

www.ikerlan.es





Microsystems

Product Development



Content

Facilities & equipment

Strategy and Challenges

Microfluidic Processing

Devices: Optics & Fluidics & Packaging

Microactuators

New challenges

European projects

Contracted projects



Main activities

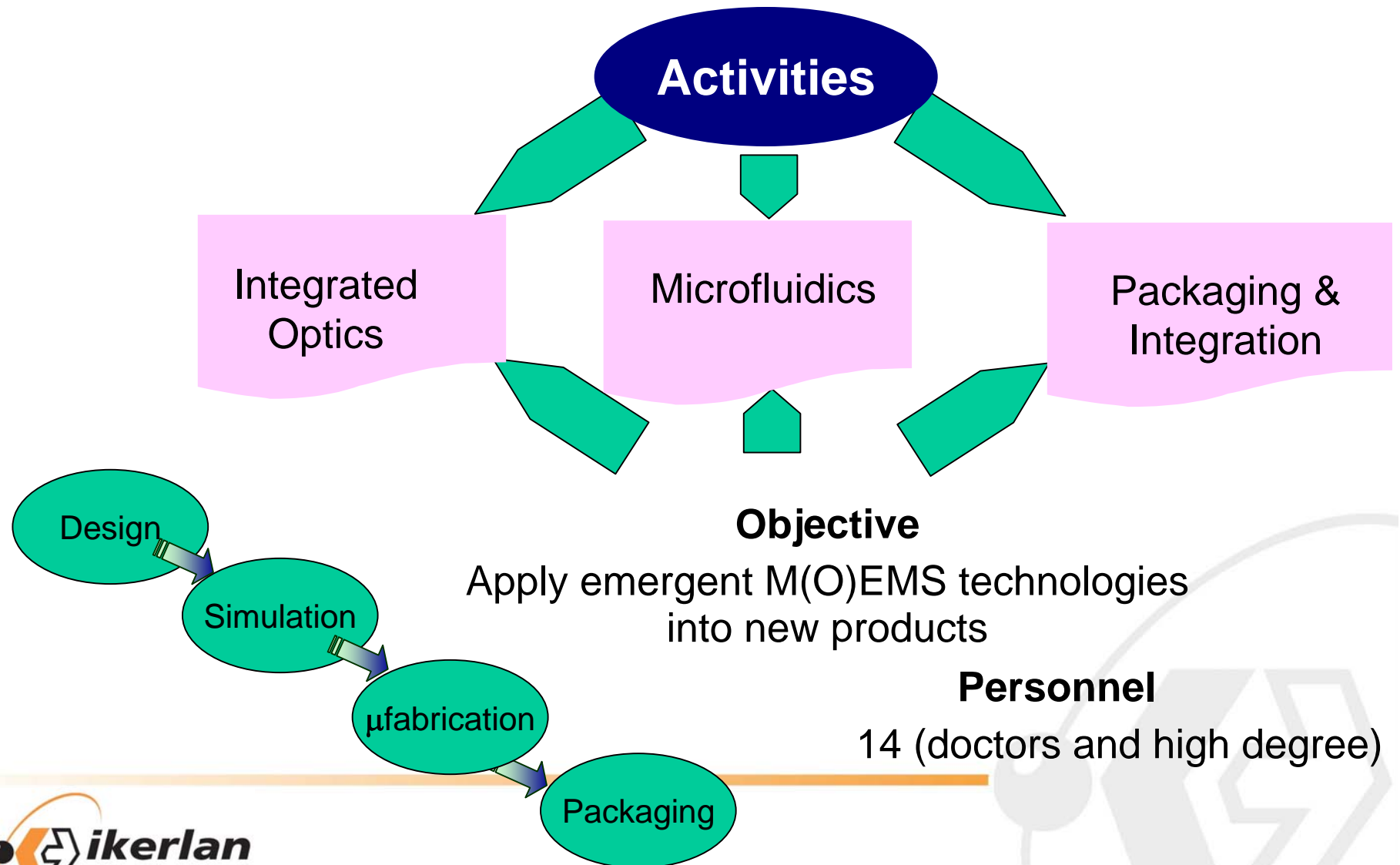

Facilities & equipment

- Clean room with 3 zones:
 - Fotolitography => class 100
 - Chemical benches => class 1.000
 - Process/characterization/packaging => class 1.000



- Fotolitography:
 - Spinners, Chemical benches,...
 - Double side mask and bond aligner

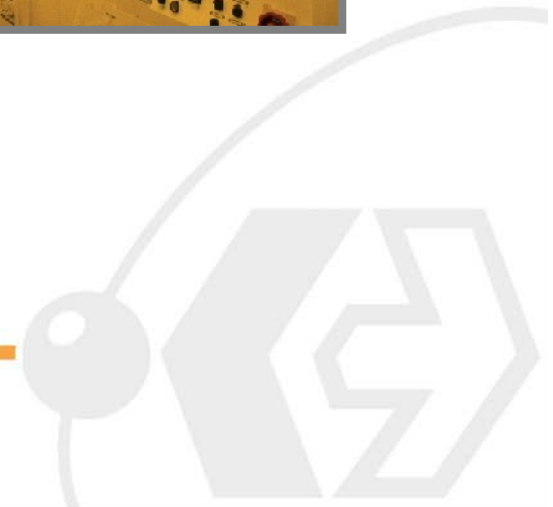

■ Processing:

- Oxidation furnaces (up to 1.100°C)
- Thin film by sputtering (nm to 2µm)
- Electroplating system
- Wet etching KOH
- Several chemical benches
- Deep plasma etching (DRIE)
- Silicon porosificación/electropolish (HF)
- Plasma cleaning system
- Dry oxide etching (RIE)
- Excimer laser

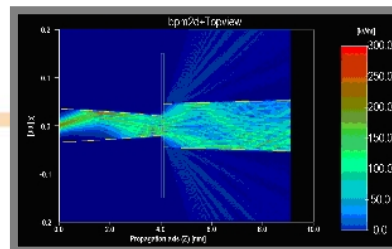
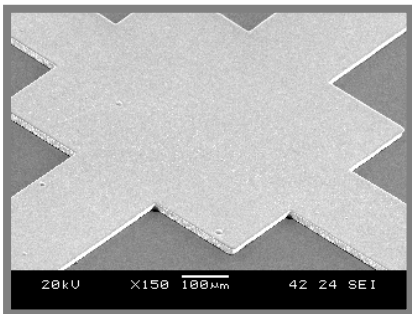
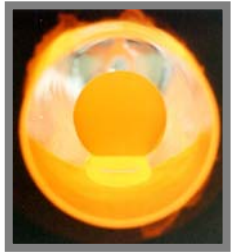

■ Packaging and housing :

- Encapsulation at wafer level (anodic bonding, eutectic, silicon-silicon)
- A dicing saw *Disco*
- A flexible machine of die attach and flip-chip
- Two wire bonder (wedge-wedge) and (ball-wedge).
- A pull and shear tests
- A microstereolithography machine

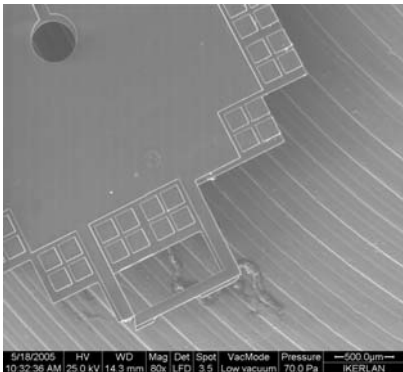

■ Characterization :

- 200 electronic microscope with an EDAX
- A non-contact optical confocal profilometer
- A microfluidic characterization bench (pressure transducers, micropumps, micromass flow meters).

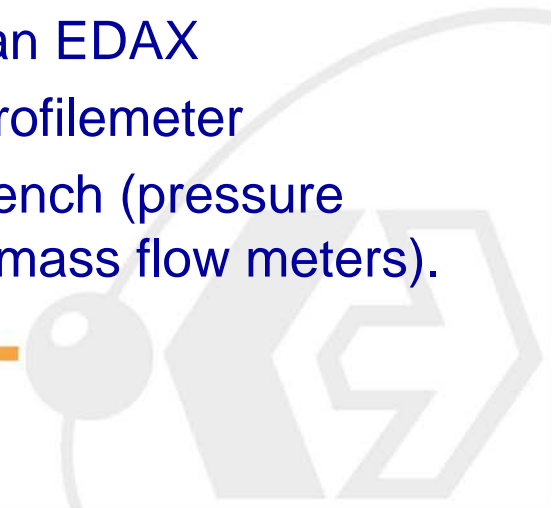

Aplicaciones Micro-tecnológicas

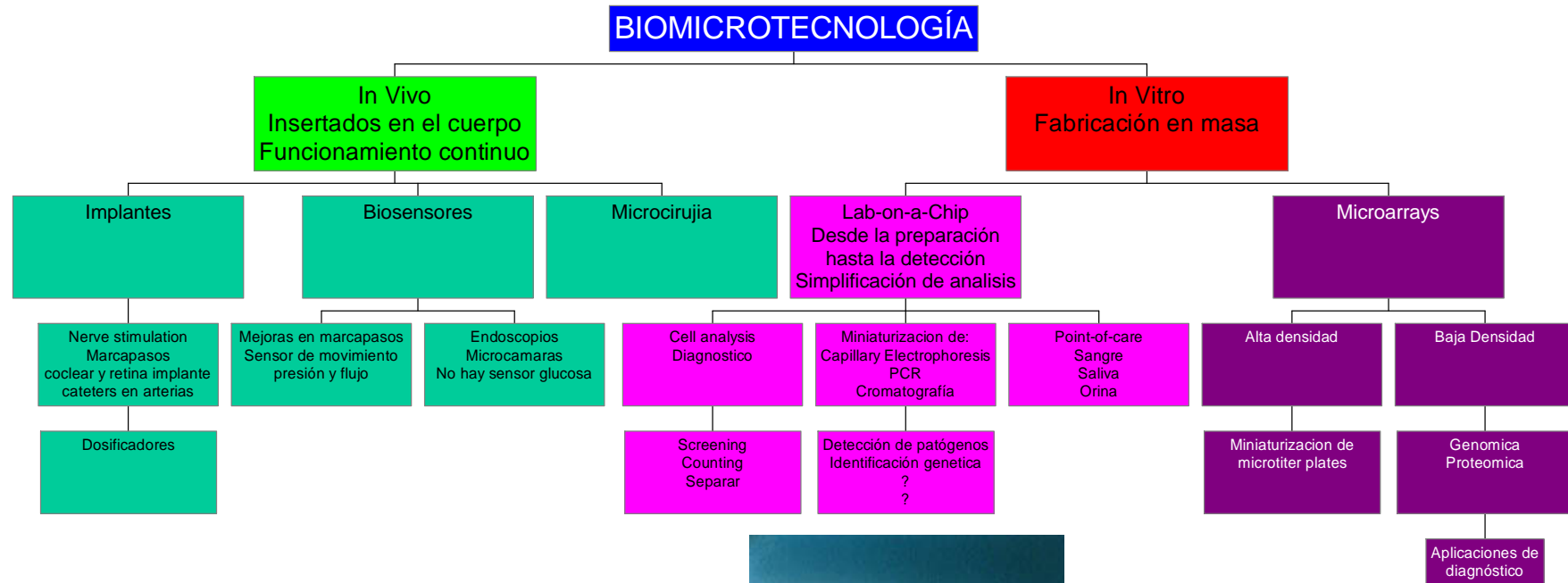

Lab-on-a-Chip evolution

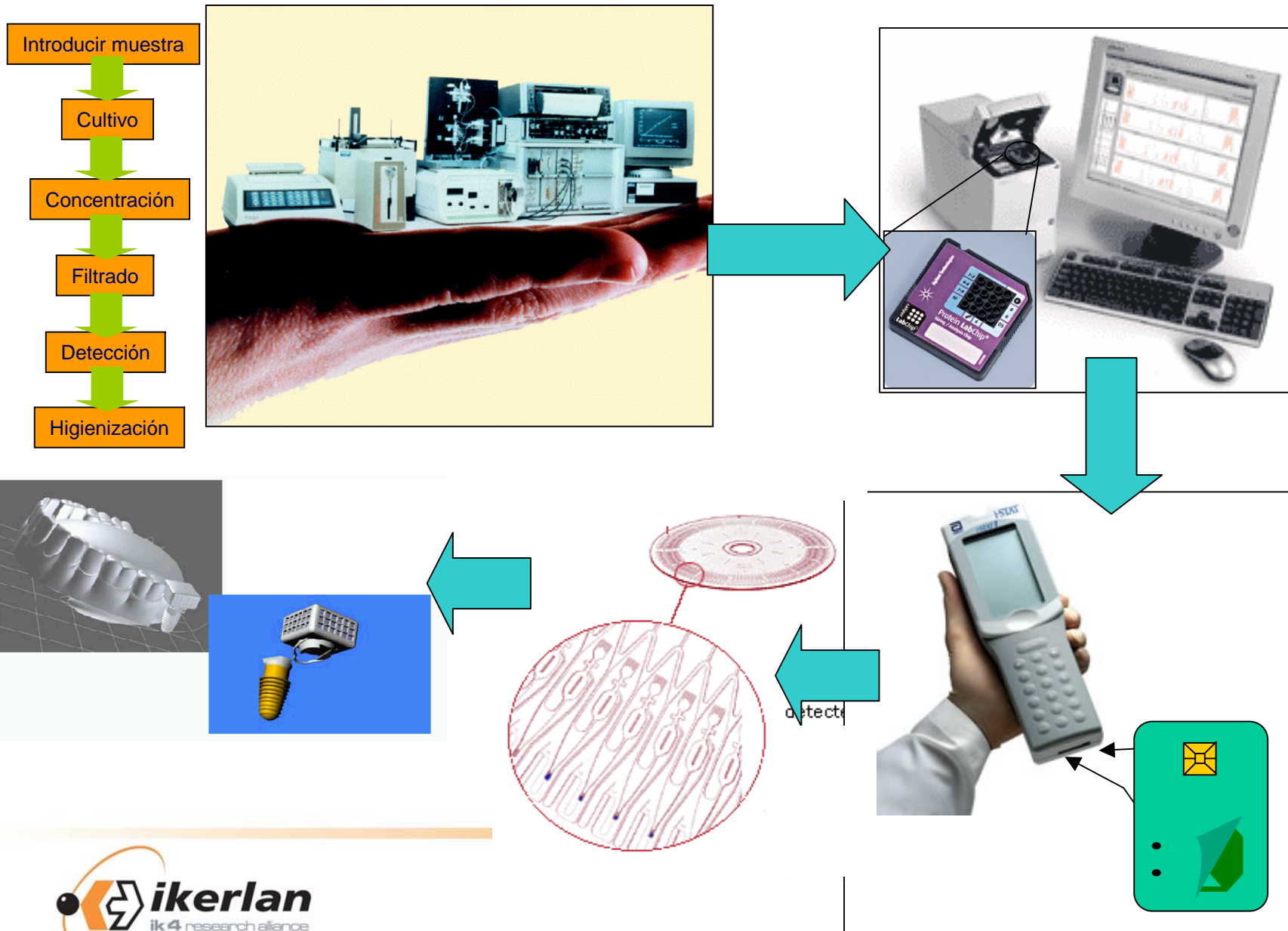

Strategy and Challenges

qPCR Labcard

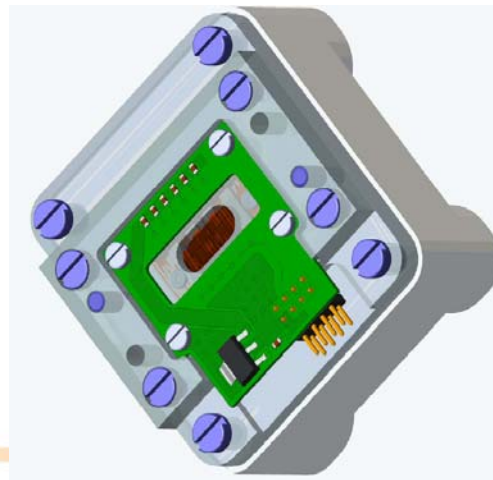
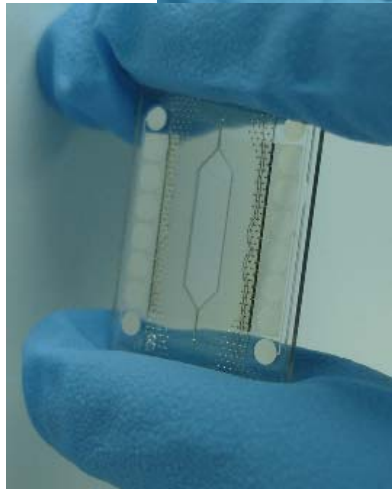

SDS GCE protein electrophoresis

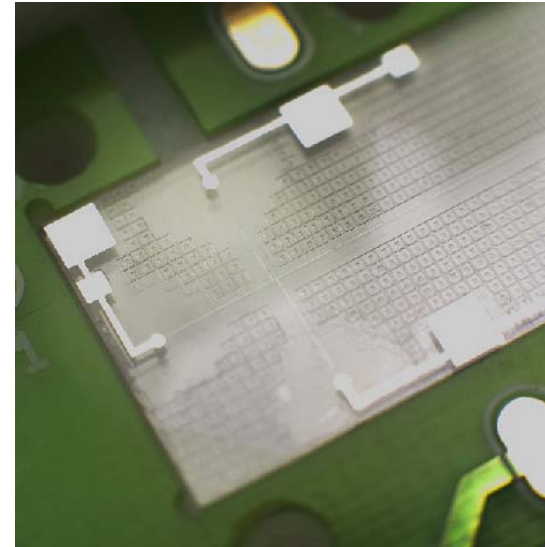

Strategy and Challenges

Monolithic

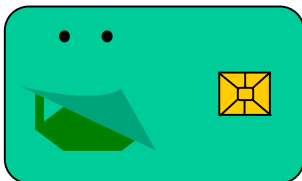
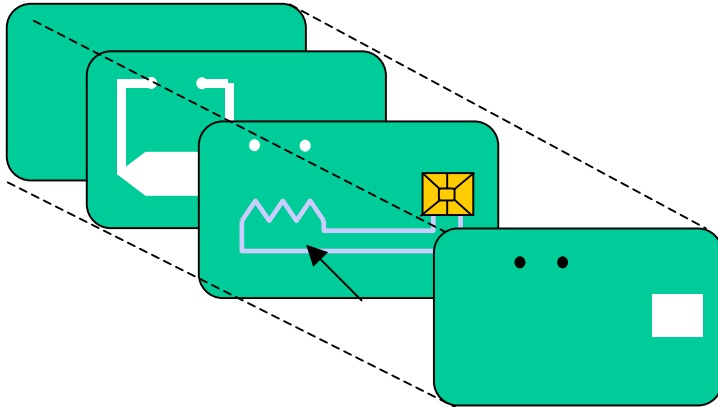

Hybrid



Input Output

Electrodes

SU8 Flex device

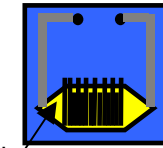
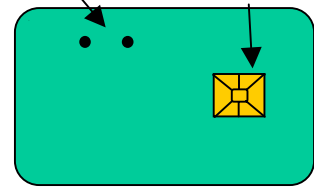

Chamber

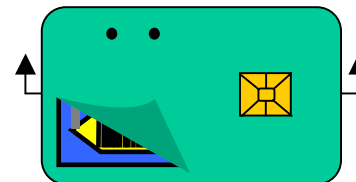
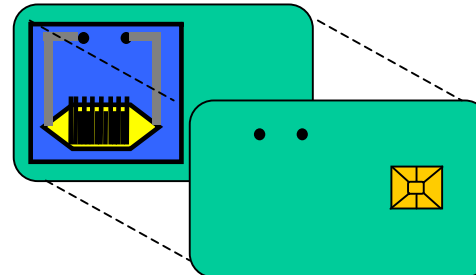

Bio Components

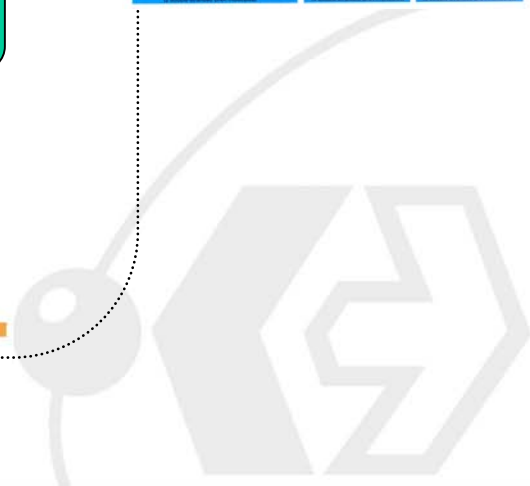
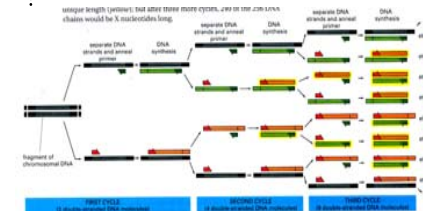
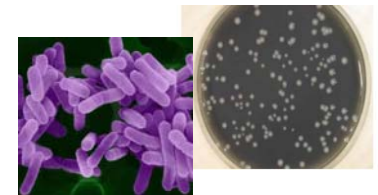

Strategy and Challenges

Rapid diagnostic Cards

- Keep things **simple as possible**
- Make use of a **thick photoresist** as a structural material

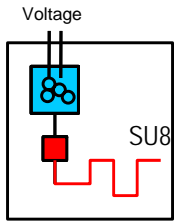
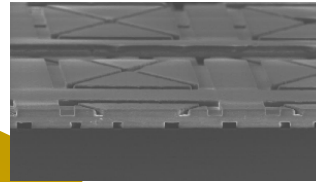
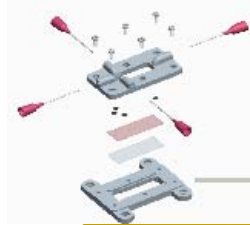

SU8 photopatterned on Silicon



First bonding



Two SU8 layers, bonded together

releasing



Two SU8 layers bonded together, after releasing

Second bonding



Three SU8 layers bonded together

releasing



Three SU8 layers, after releasing

REPEAT THE PROCESS

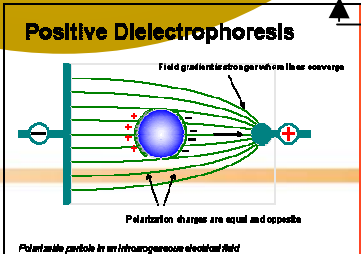
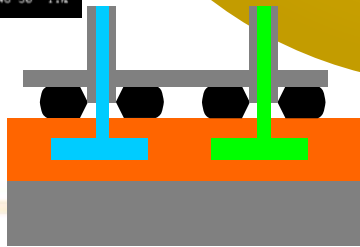
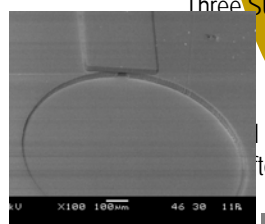
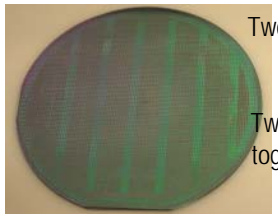
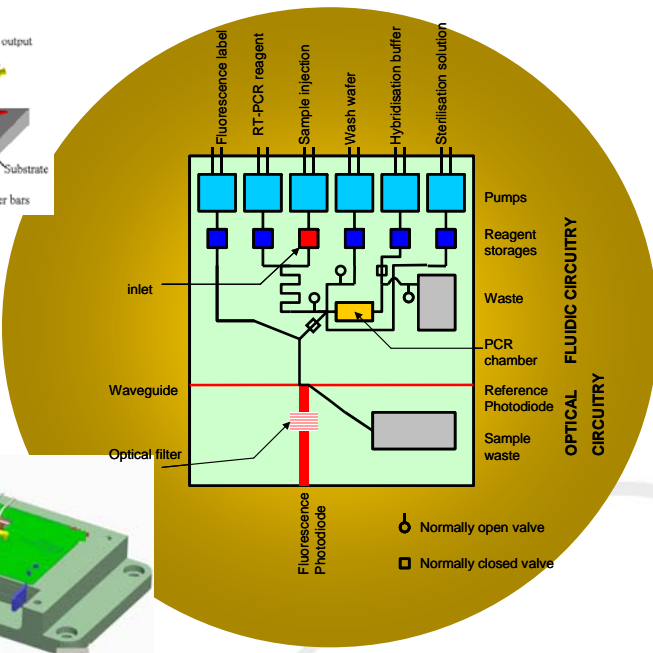
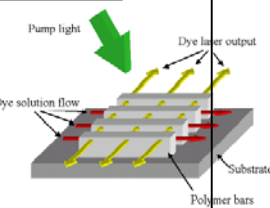

Microfluidic Processing

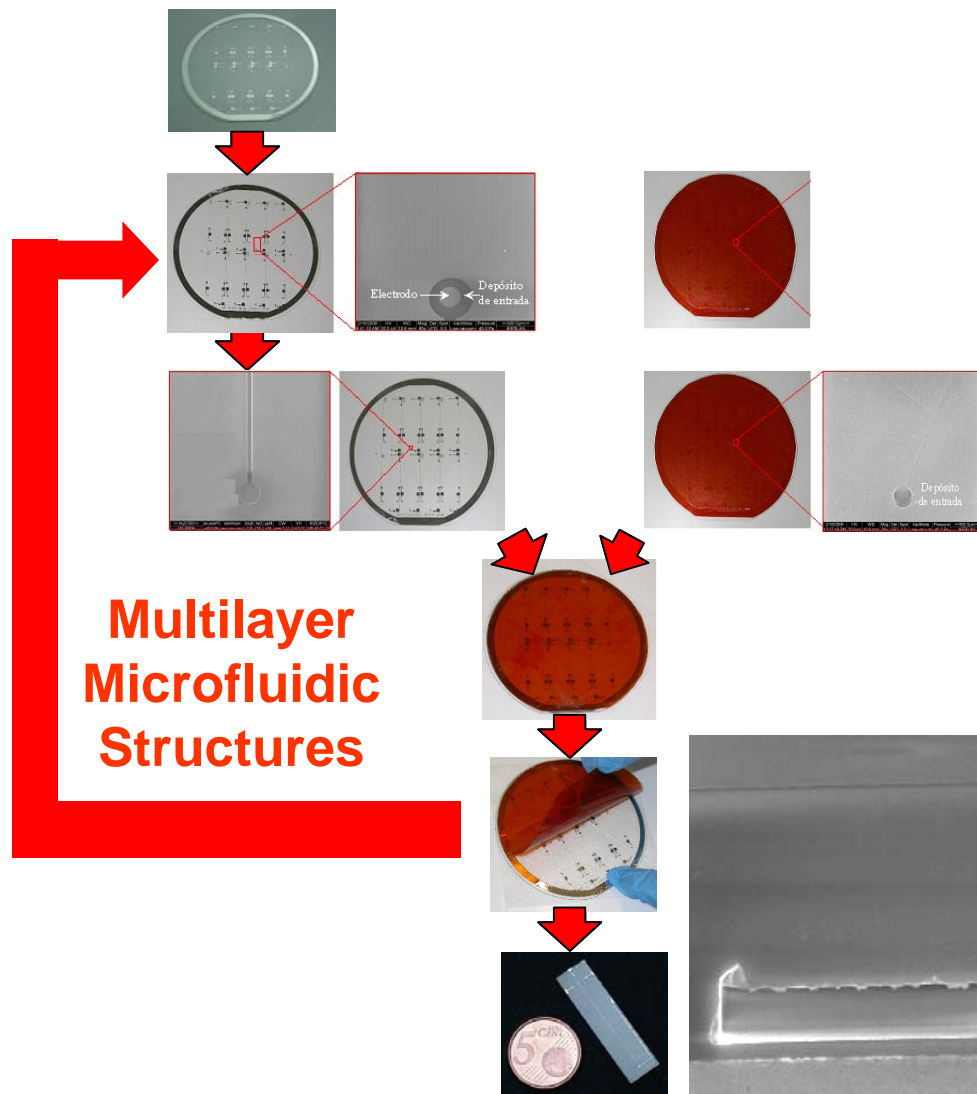

- **Low cost polymeric** CMOS compatible microfluidic technology for LOC applications
- A truly portable LOC device
- **Keep things as simple as possible**
- SU-8 UV Negative photo-resist. Thermosetting Polymer. Chemically stable < 250°C. 1µm-500 µm thickness. Suitable material for MEMS applications
- **Simplifies packaging and replacement of microfluidic devices, avoiding drilling etching process**

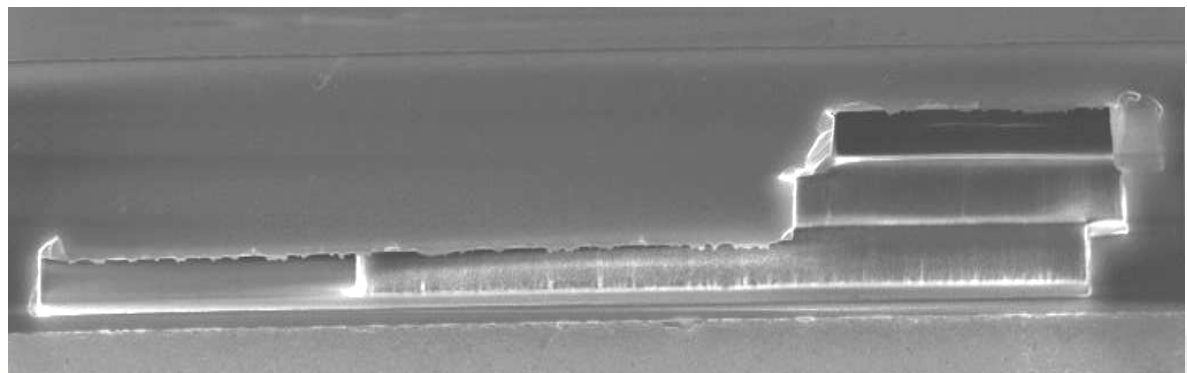

Microfluidic Processing

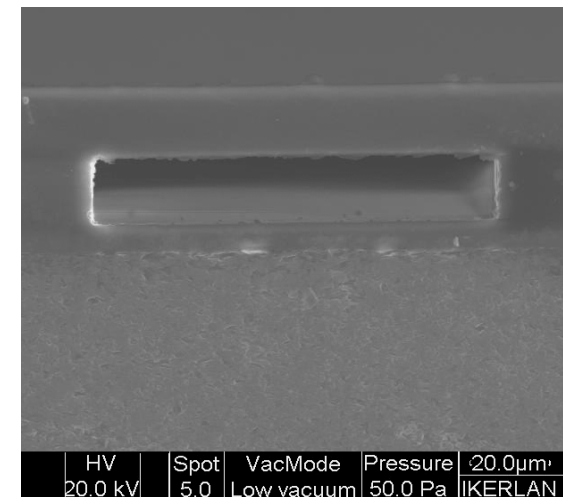
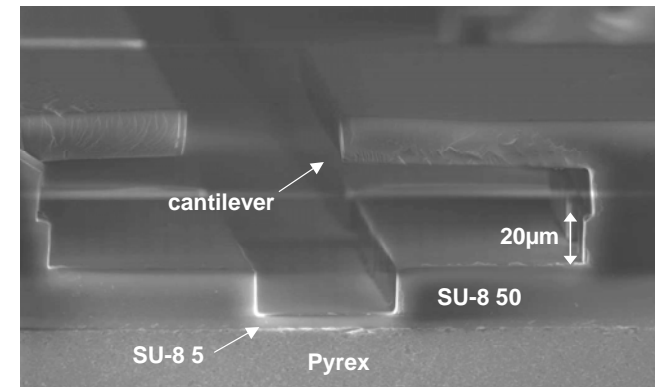
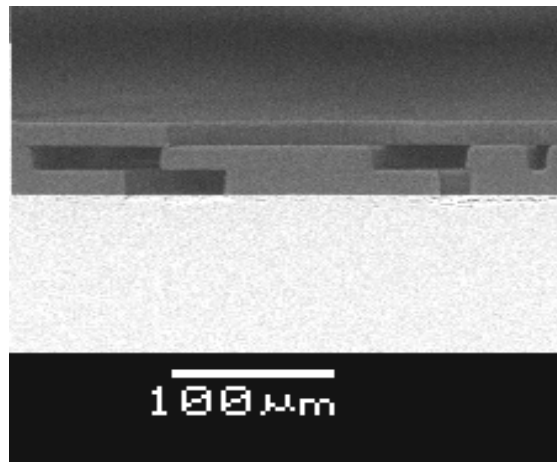
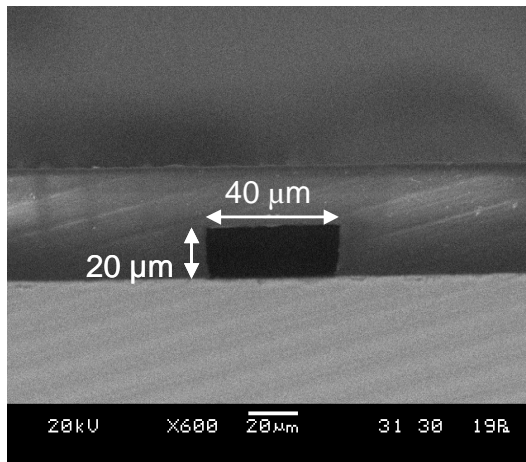

- Fabricación process described here opens new complex 3D structures.
- Simplifies packaging of microfluidic devices, avoiding drilling etching process
- A plastic capsule and an o-ring per reservoir is enough to introduce liquid into channels
- Channel withstand liquid pressures up to 600 KPa

Microfluidic channels

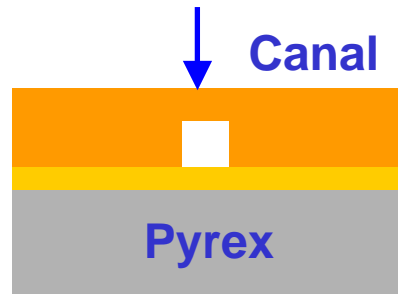
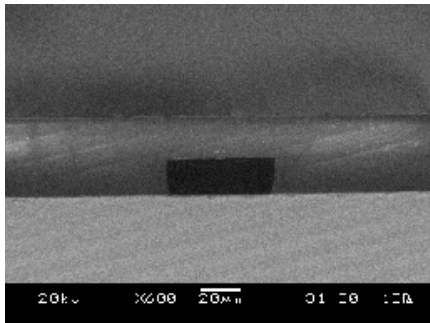

New Bonding between flexible layer thickness (e.g. 20um/60um, 20um/130um, 60um/130um)

Higher channels up to 130 microns (so far)

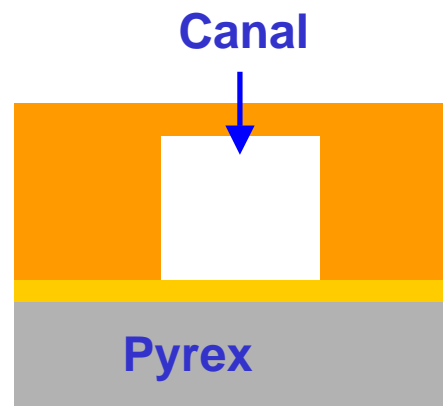
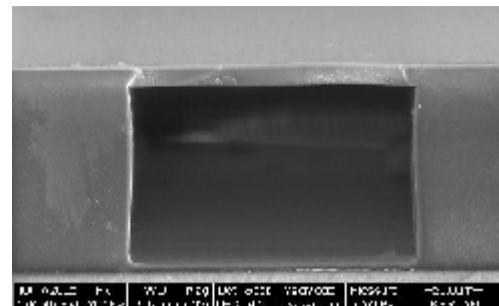

More robust and reliable multilayer process have been achieved (100% wafer yield)

Microfluidic chambers

Wider chambers up to 6 microL

Working on higher volumes

There is no need for columns

Surface to Volume Ratio

150cm²/cm³

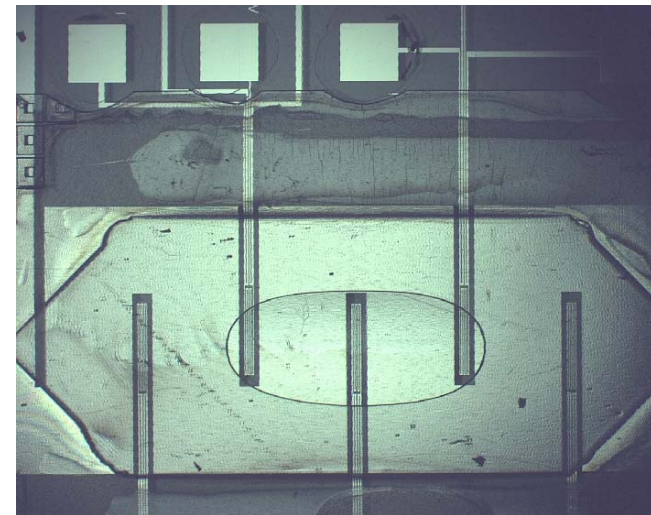
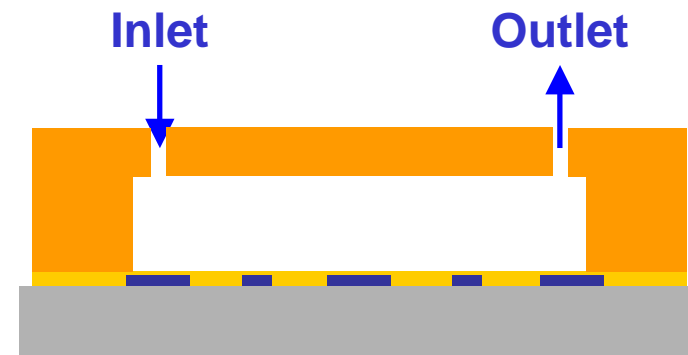

Devices: Fluidic and Electrical Packaging

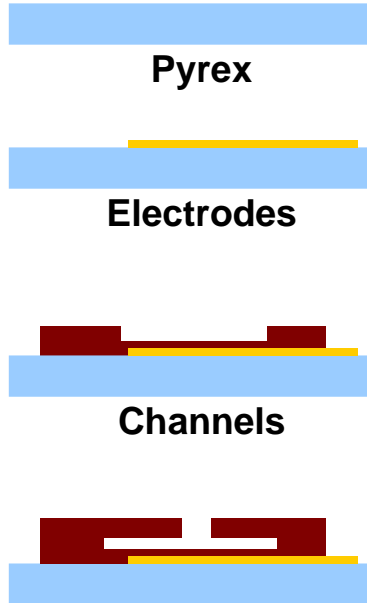

Current Strategy

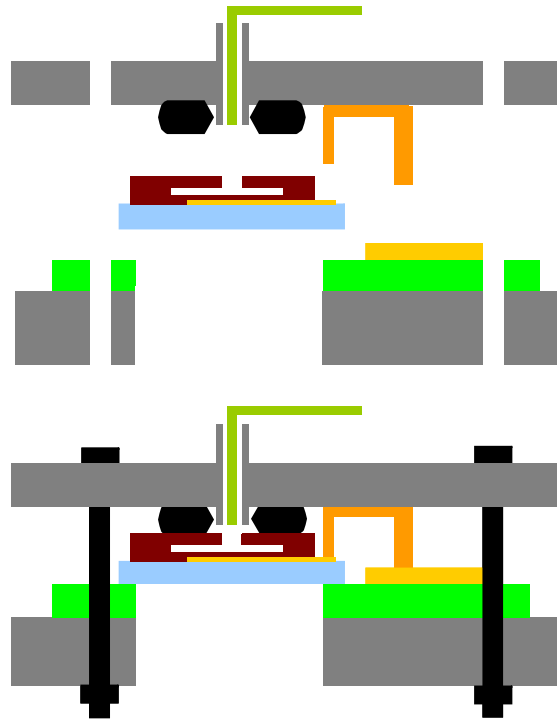

Future Strategy



Easy connection



MZ interferometer with a fluidic circuitry

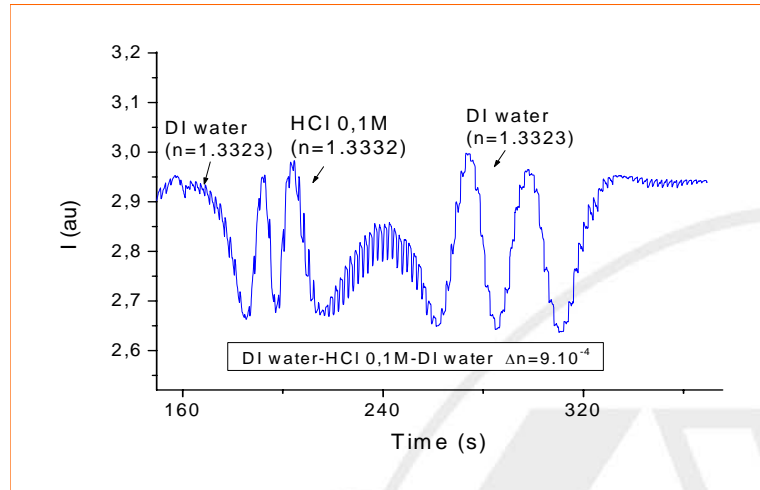
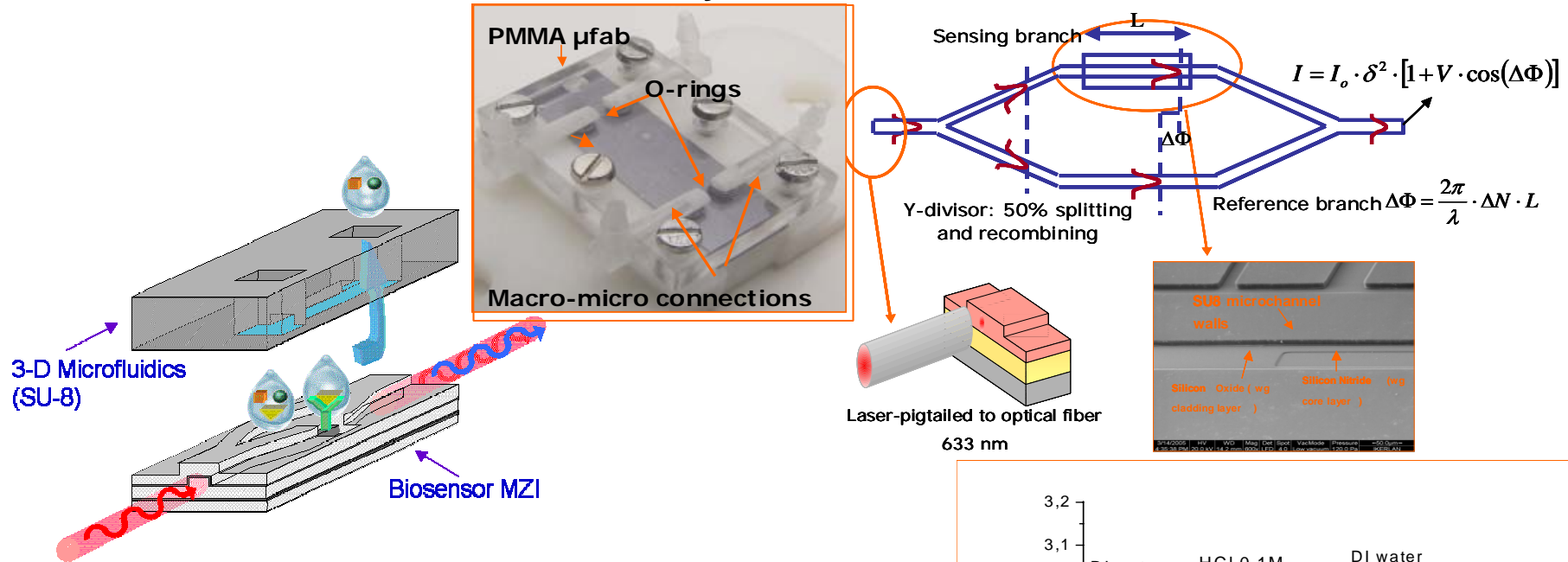

✚ Microfluidic characterisation of the SU-8 microchannels : Friction Factors, Roughness-viscosity models

✚ How different microfluidic behaviour change the diffusion of the molecules, immobilization

F. Blanco's thesis

Devices: Optics & Fluidics & Packaging

qPCR + Heating control

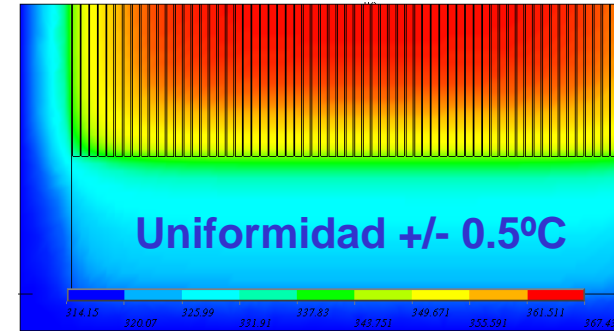
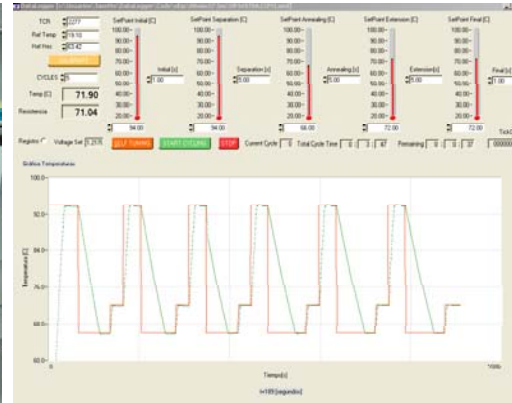
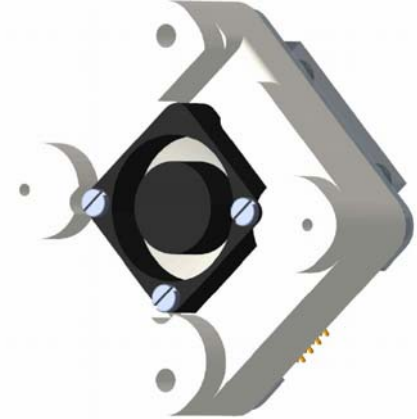
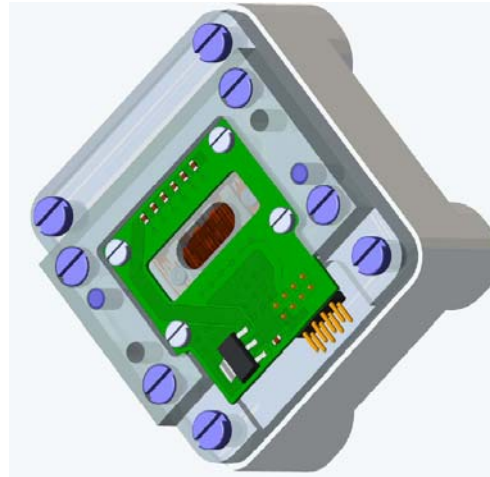
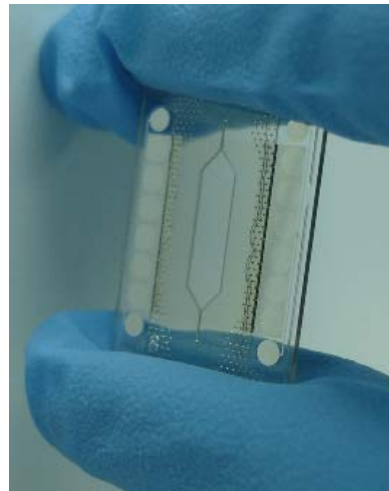

Chip Size: 16 x 21 mm
 Chamber Size: 12 x 7 x 130µm
 Max. Volume: 6µL

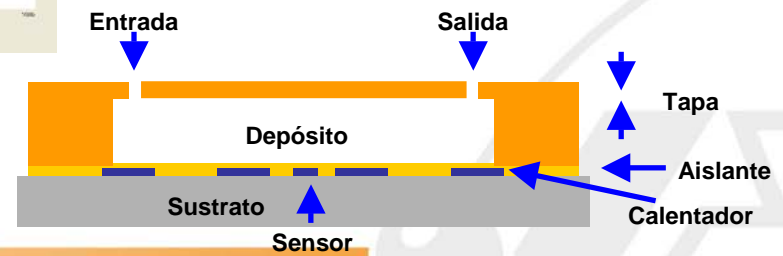

Salmonella DNA multiplication in a microPCR CHIP

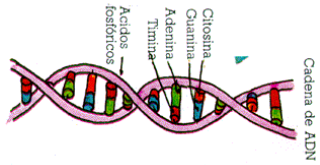

antes

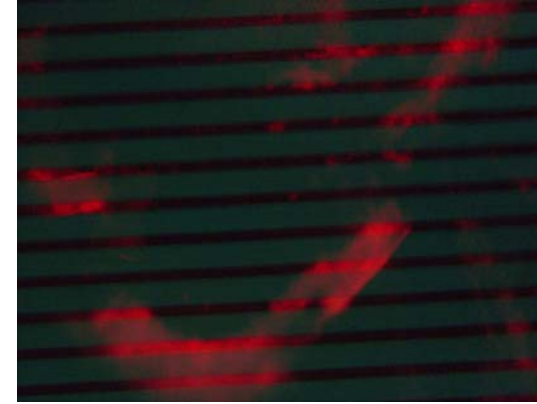

después

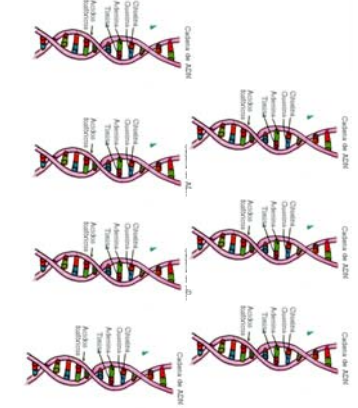

1 2 3

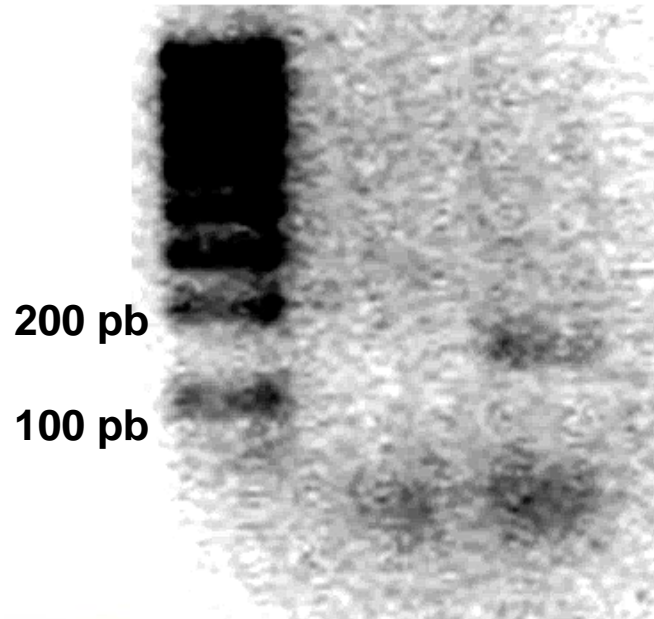

1. Marker, de 100 a 1000 pb, de 100 en 100pb

2. Control negativo

3. Control positivo

← 158 pb

← primers

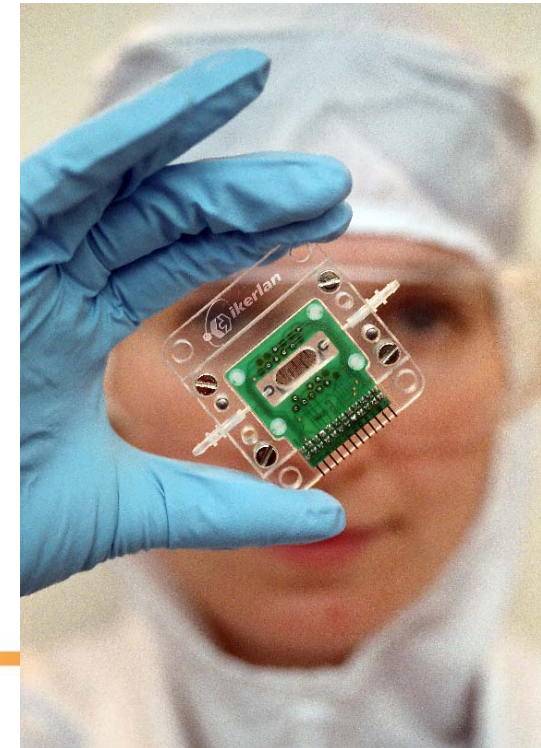

Design

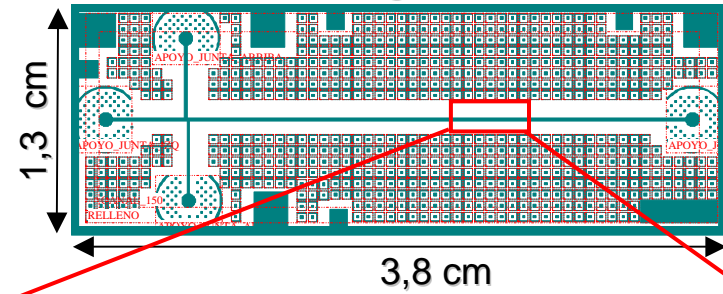

Electrophoresis Chip

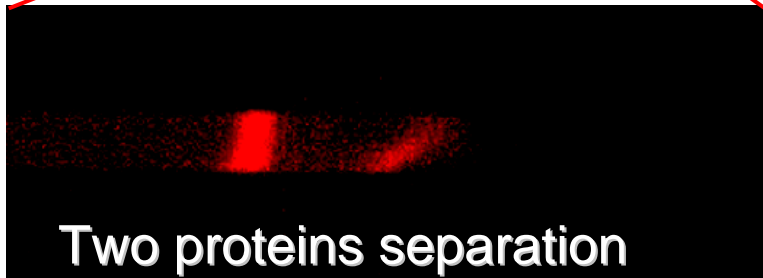
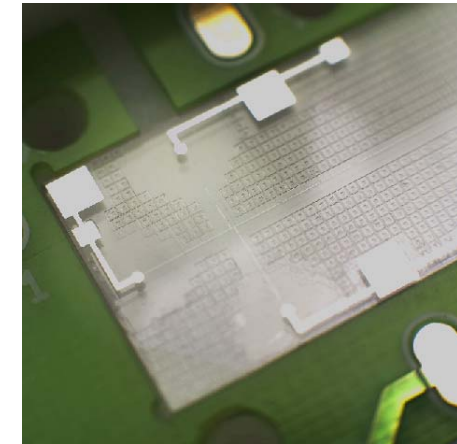
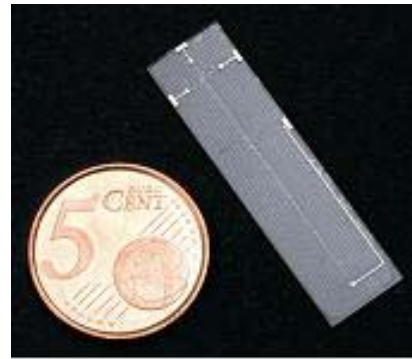

Easy replacement

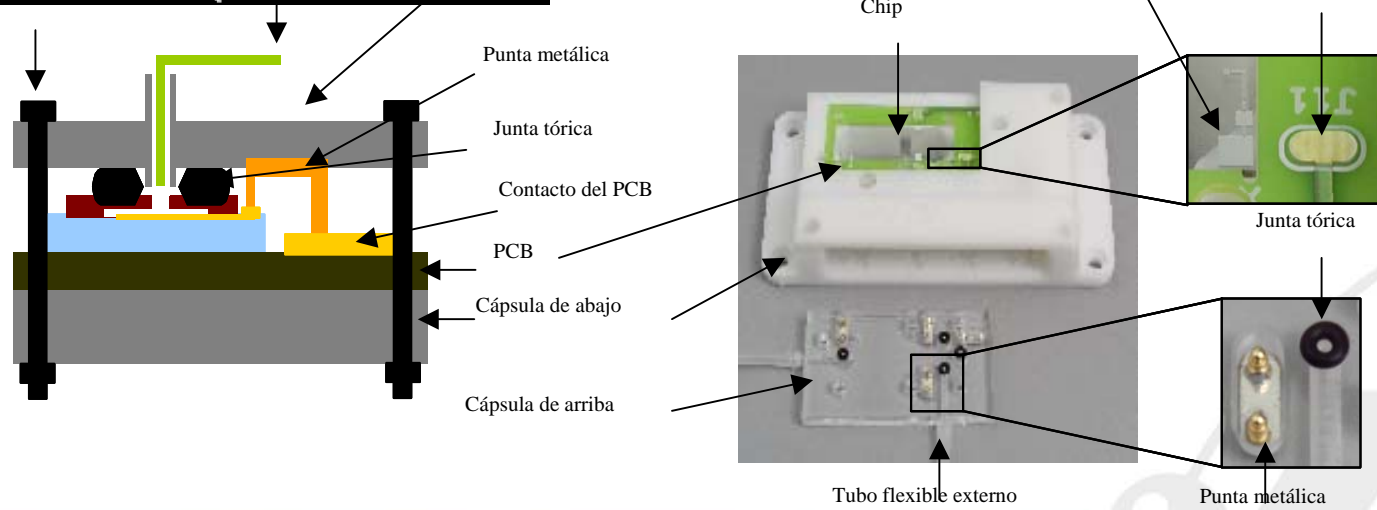

Protein Electrophoresis Device

SDS GCE protein electrophoresis in a Polymeric device

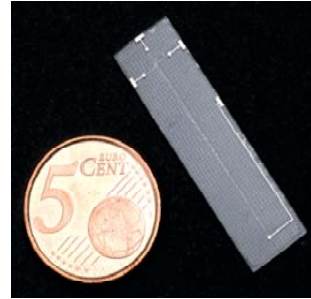
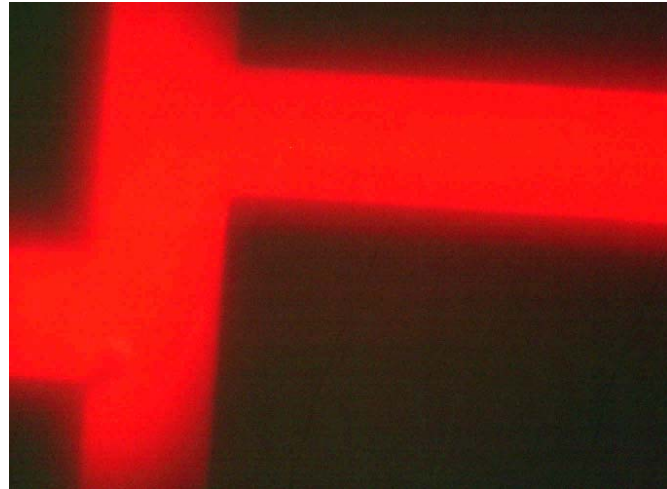

Electrophoresis device

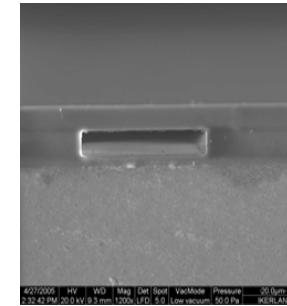

Microchannel cross section

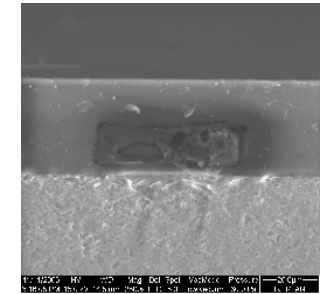

Microchannel filled with polyacrylamide

Separation of trypsin and phosphorylase

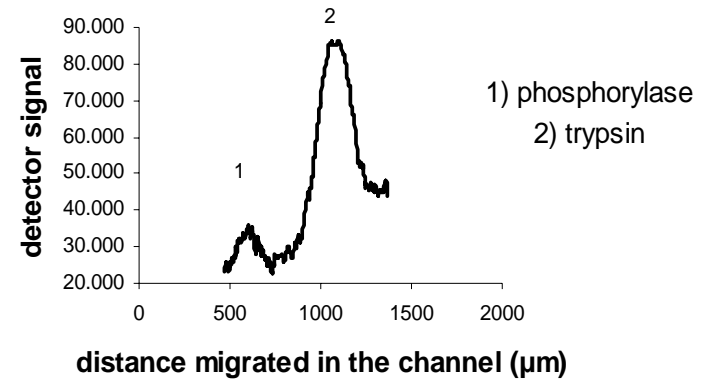
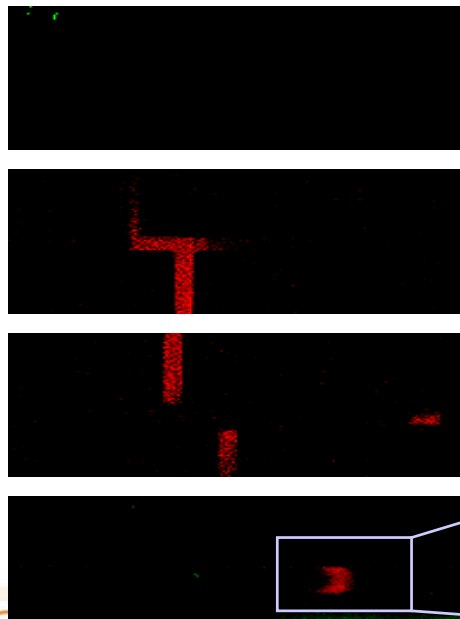

After 20 sec

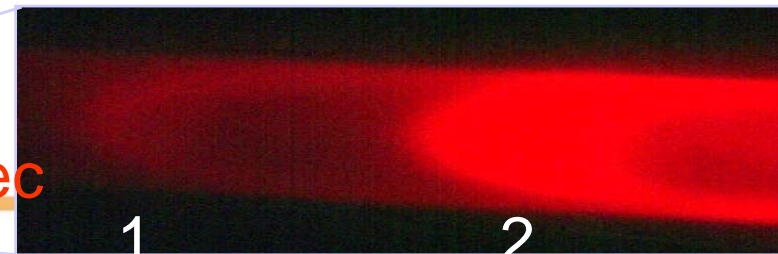

SDS GCE protein electrophoresis Characterisation

- Very low adsorption of proteins on SU8 in comparison with other polymers
- Currently working on electrochemical detection

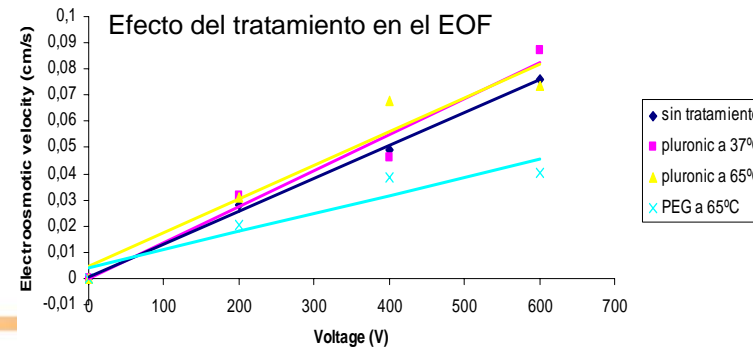
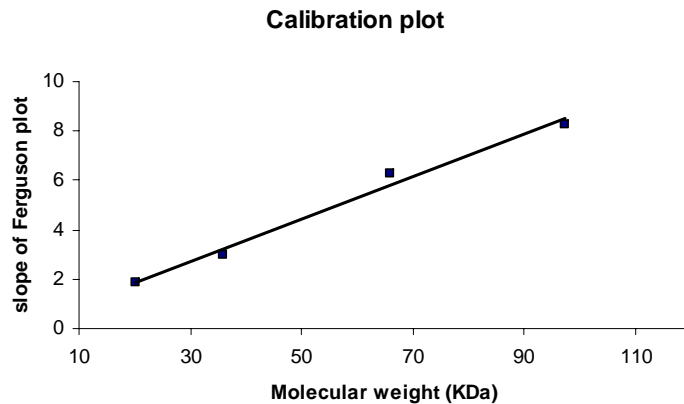
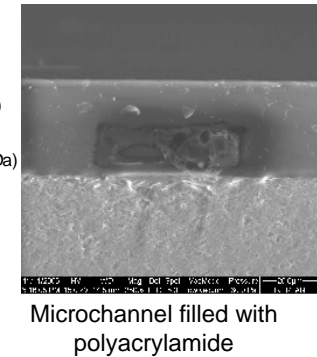
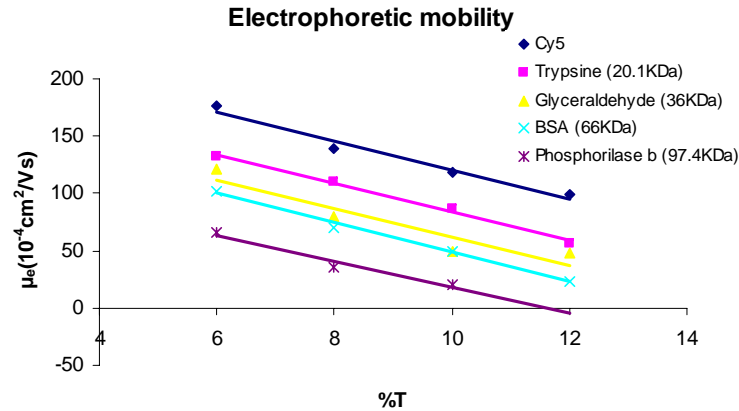
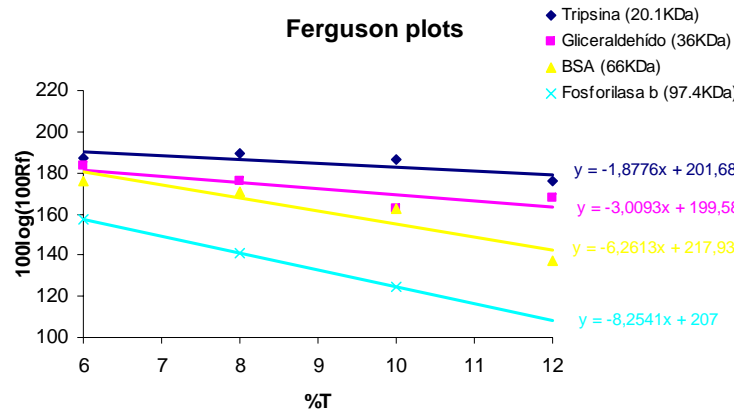

Microactuators

Metallic microvalve magnetically driven

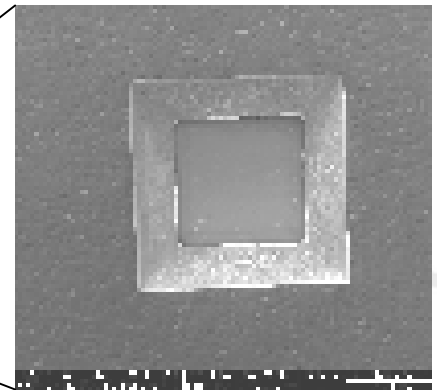
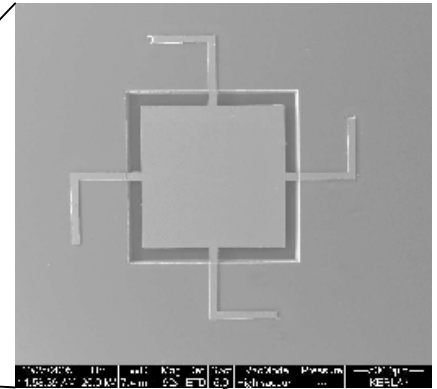
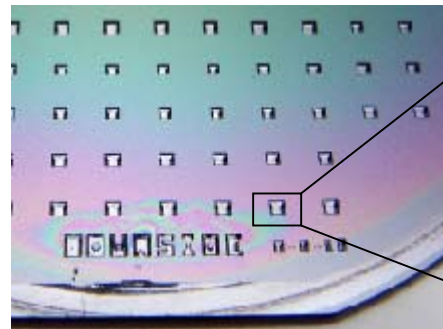
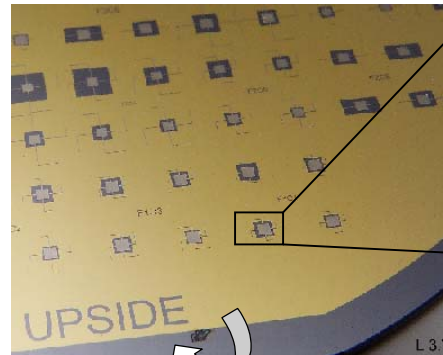
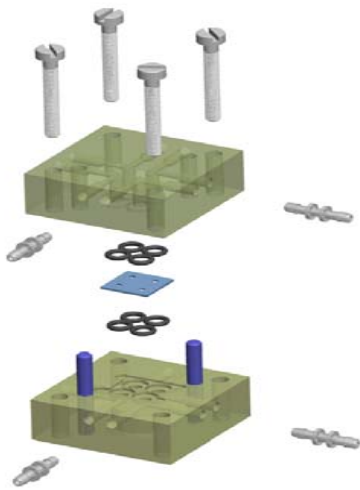
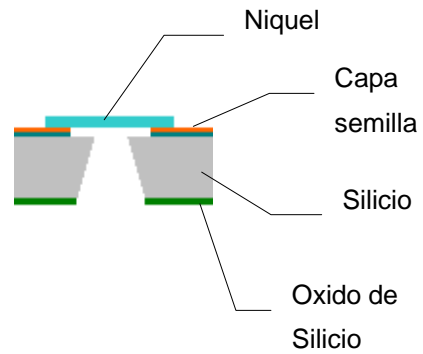
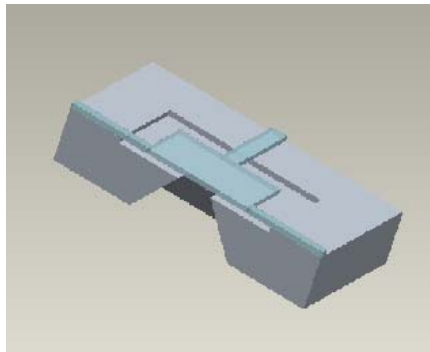

M. Tijero's thesis

Electrolisis pump

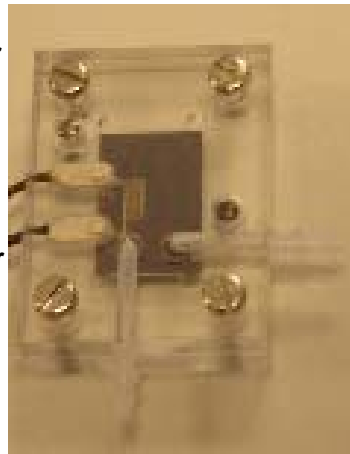
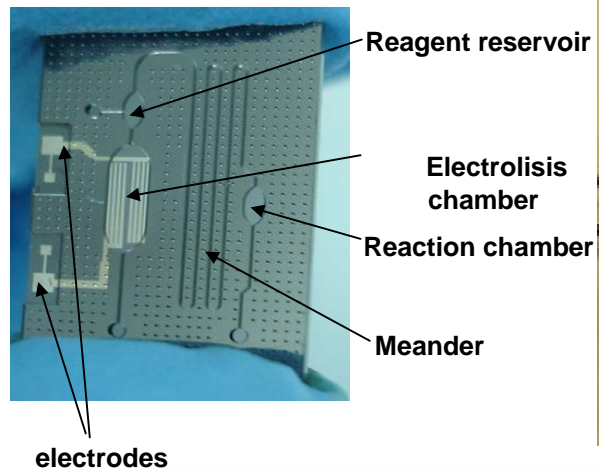
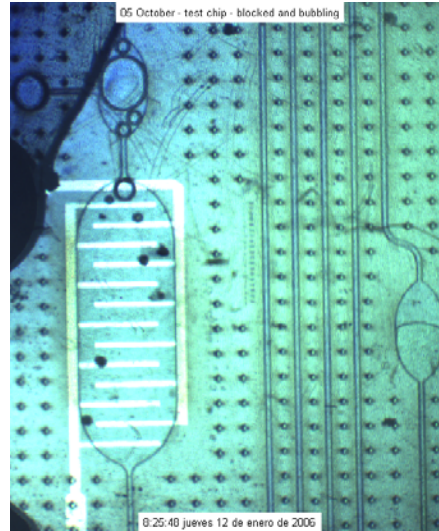
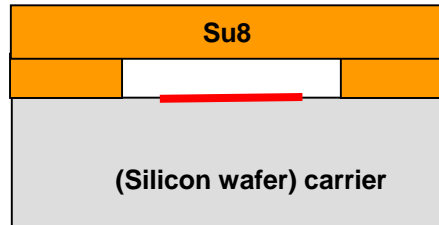

SU8 membrane

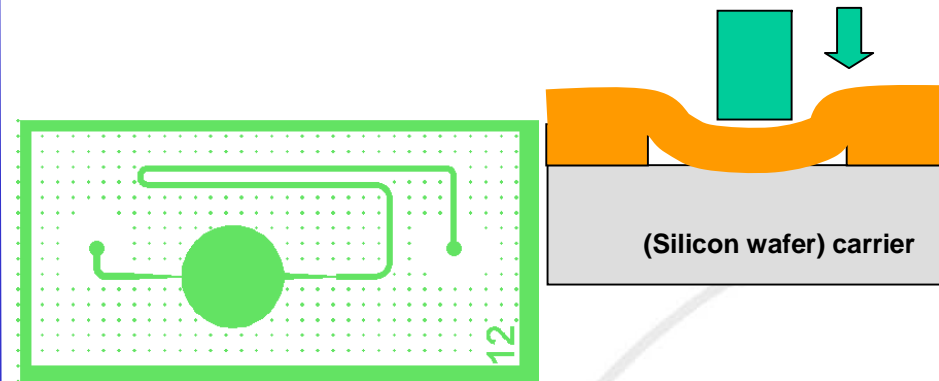
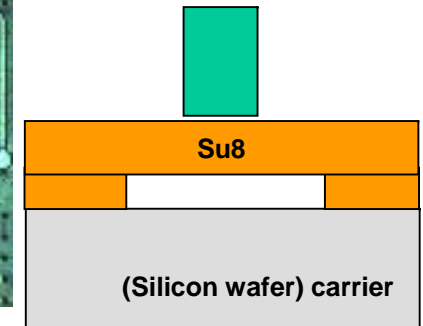
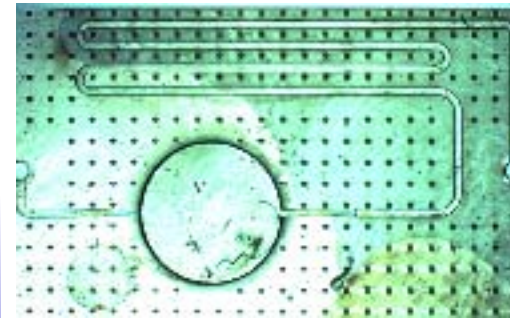

Check Valve & Flow sensor

Embedded microcantilevers

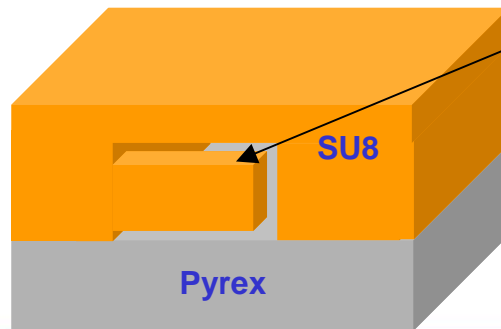
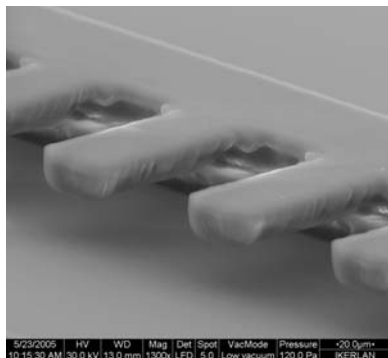
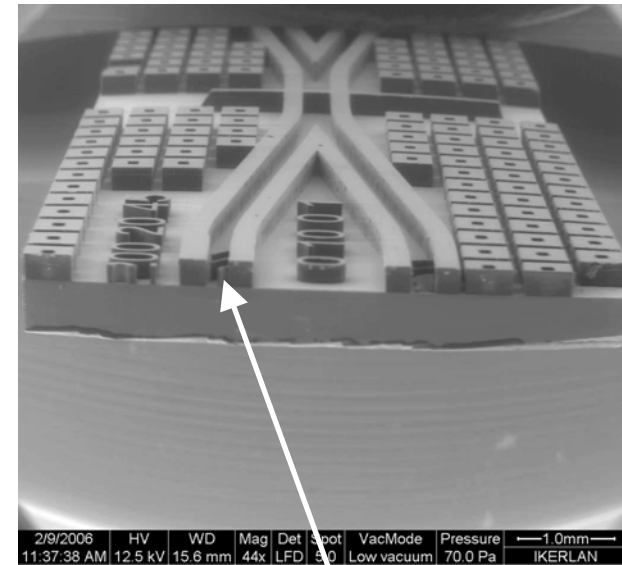
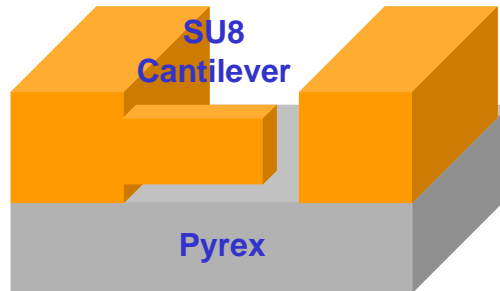
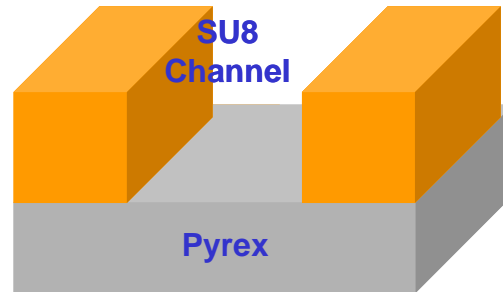

Embedded microcantilevers

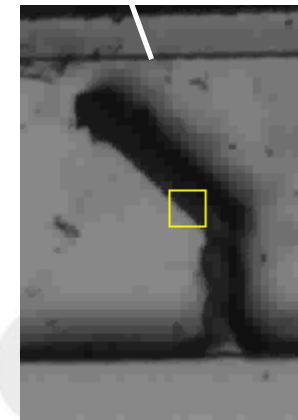

Split-and-Recombine Micro-Mixer

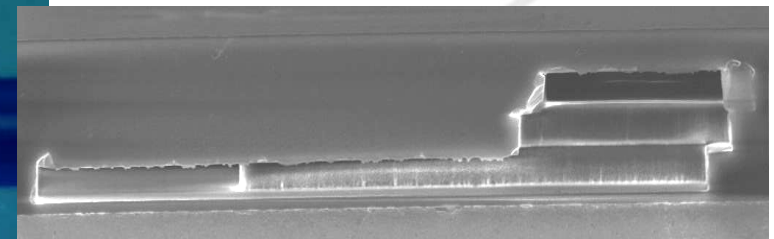
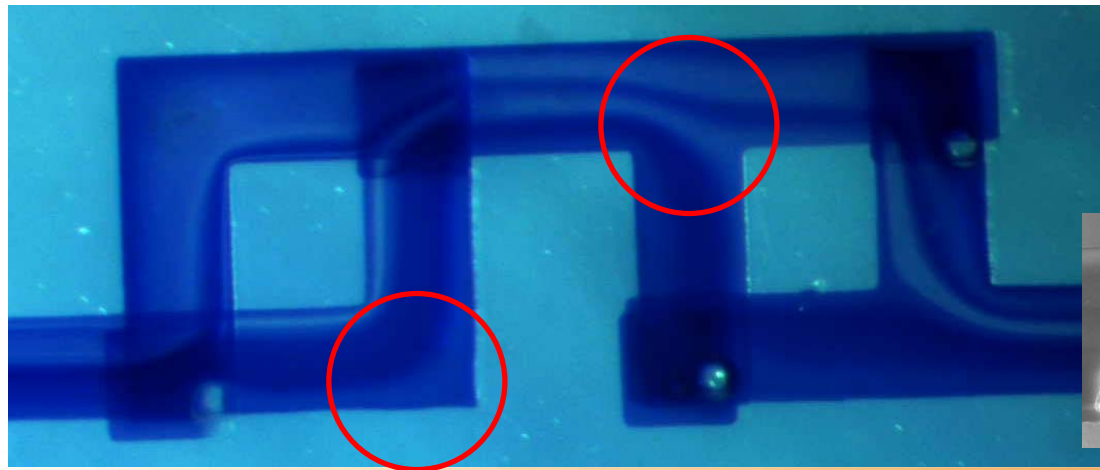
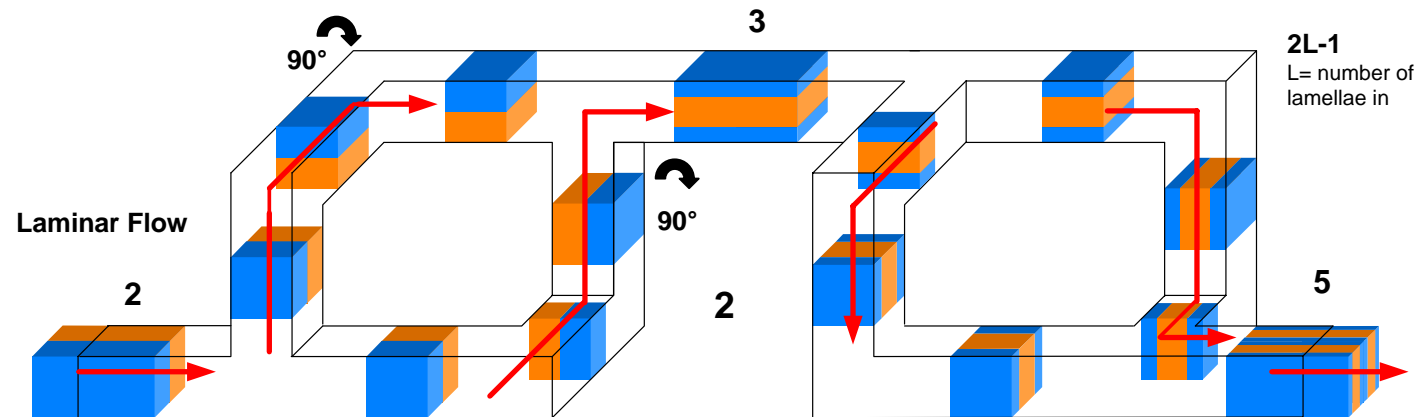

Sample concentration

El campo magnético atraerá a las partículas magnéticas que previamente han capturado a las sustancias biológicas a detectar. De esta forma se produce una concentración de la muestra.

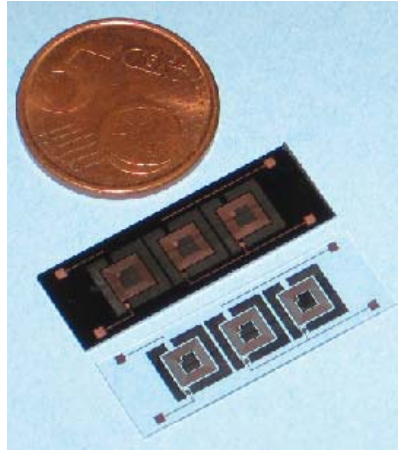

Electroimanes fabricados

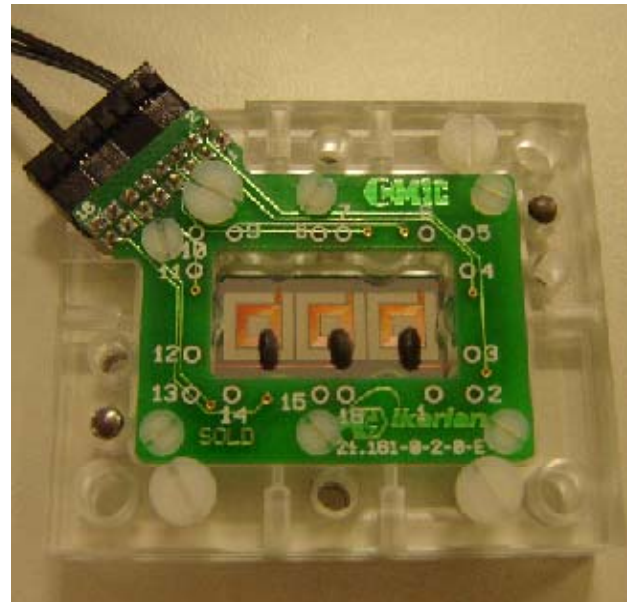

Electroimanes encapsulados

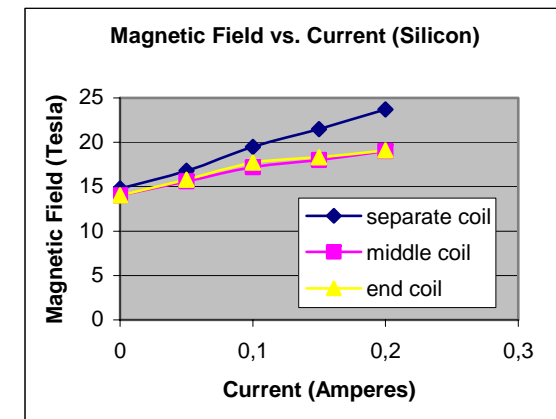

Medición del campo magnético

New challenges: devices on flexible substrates

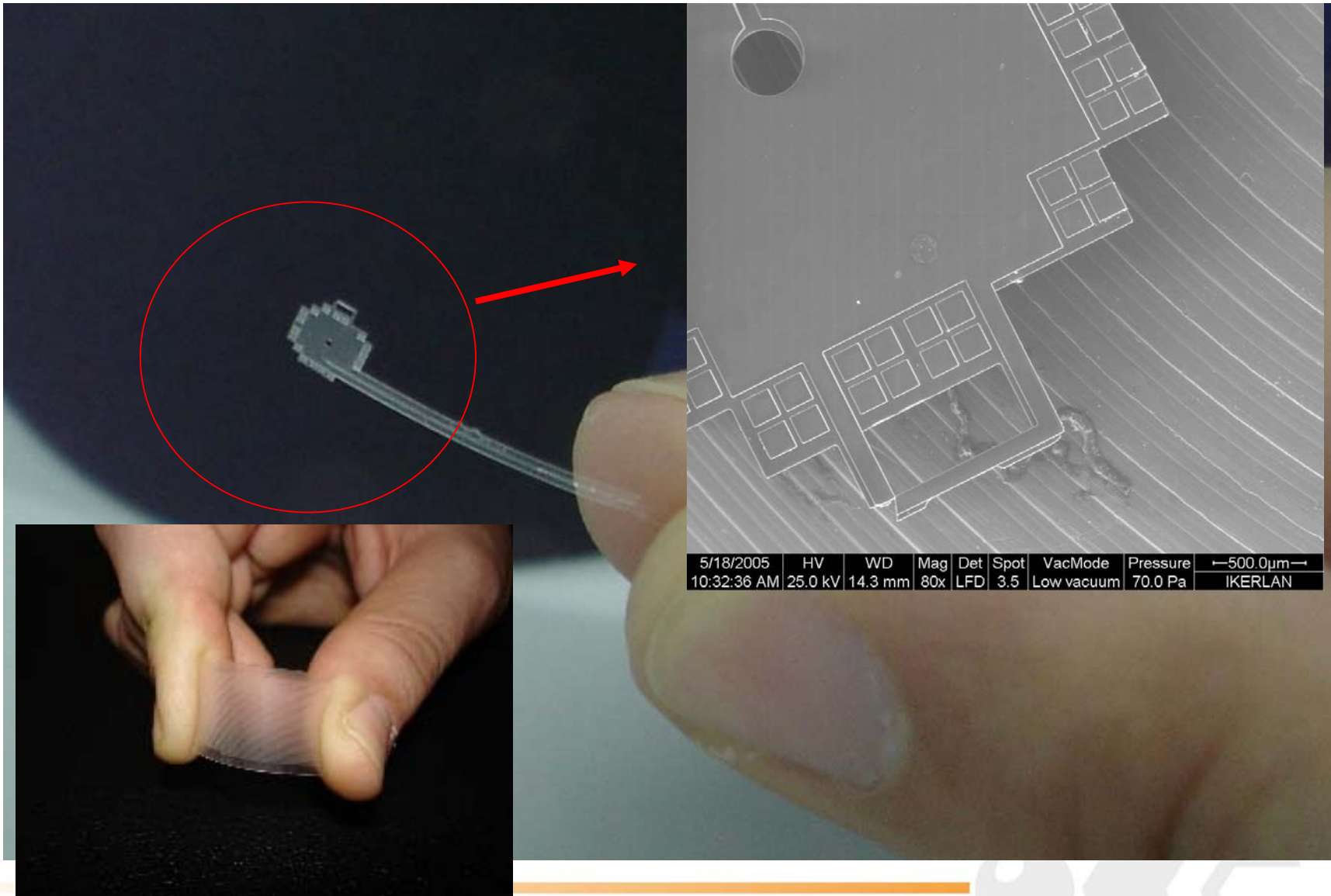

Fabrication of flexible devices

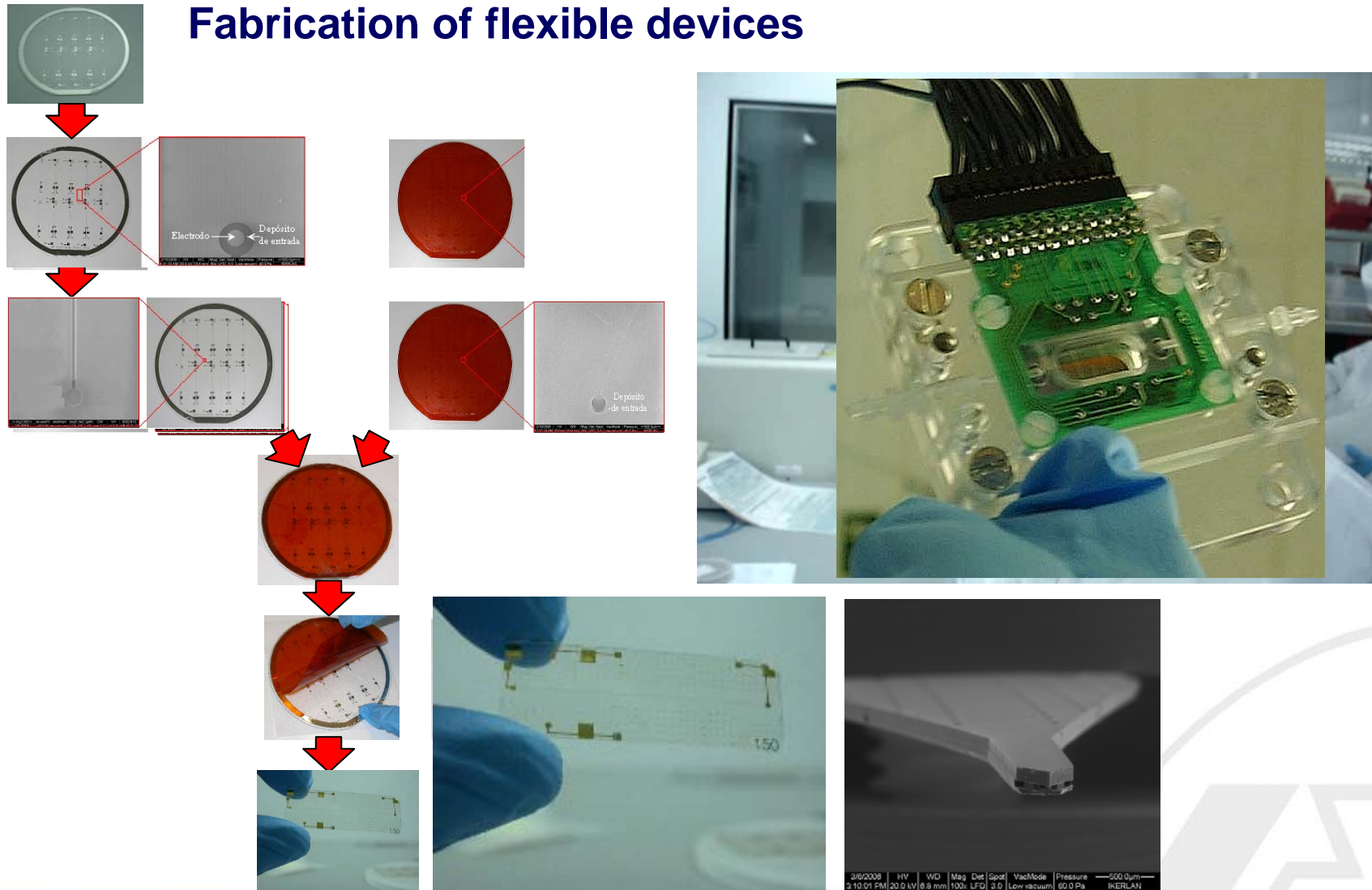

Packaging of flexible devices

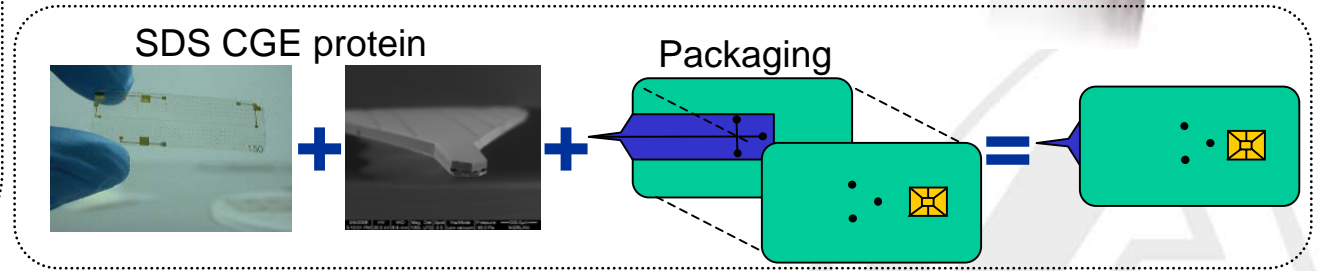
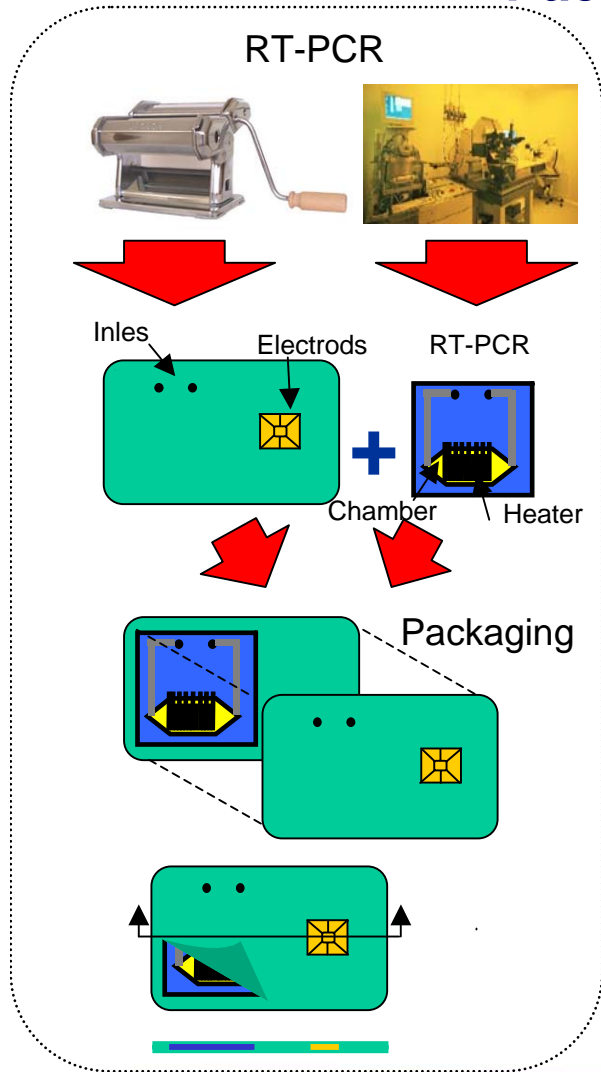

Participant name	ID	Type	Country
IKERLAN	1	RTD	SPAIN
GAIKER	2	RTD	SPAIN
MIC	3	RTD	DENMARK
DFVF	4	GOV	DENMARK
ITE	5	RTD	POLAND
EVGroup	6	SME	AUSTRIA
MICRORESIST	7	SME	GERMANY
SILEX Microsystems	8	SME	SWEDEN
BIOEF	9	PNP	SPAIN

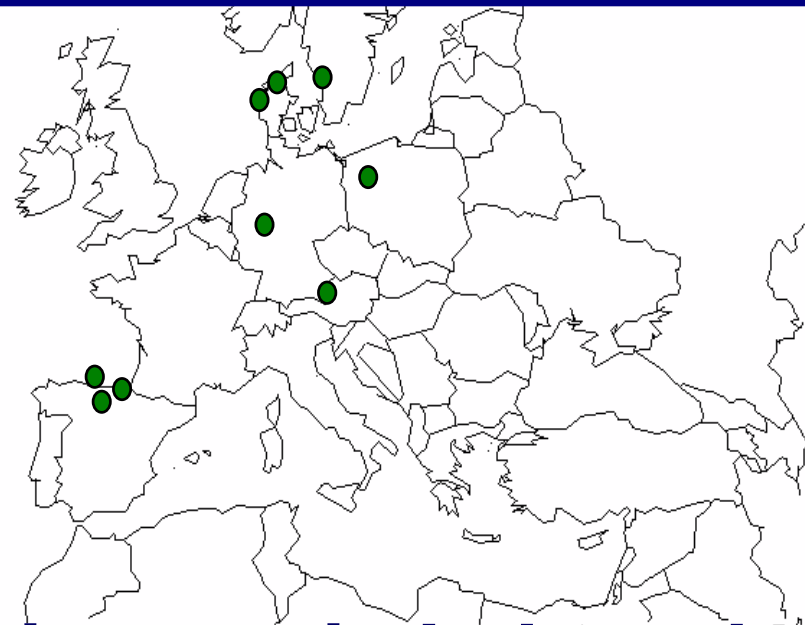

Mass Produced Optical Diagnostic Labcards Based on Micro and Nano Layers

To obtain for the first time a fluorescence diagnostic labcard (μ TAS system) that will dramatically simplify its use without decreasing efficiency.



Project coordinator: Jesús M. Ruano
IKERLAN

Project methodology

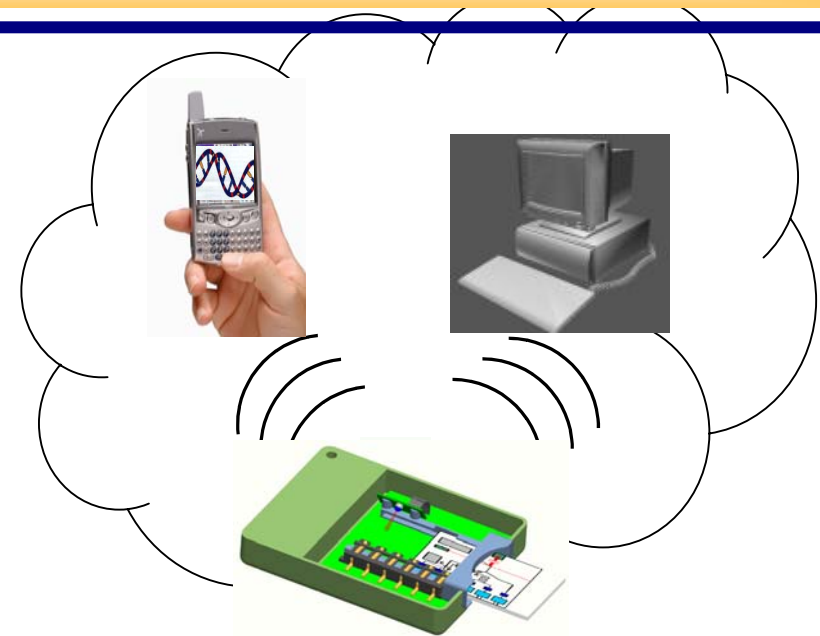
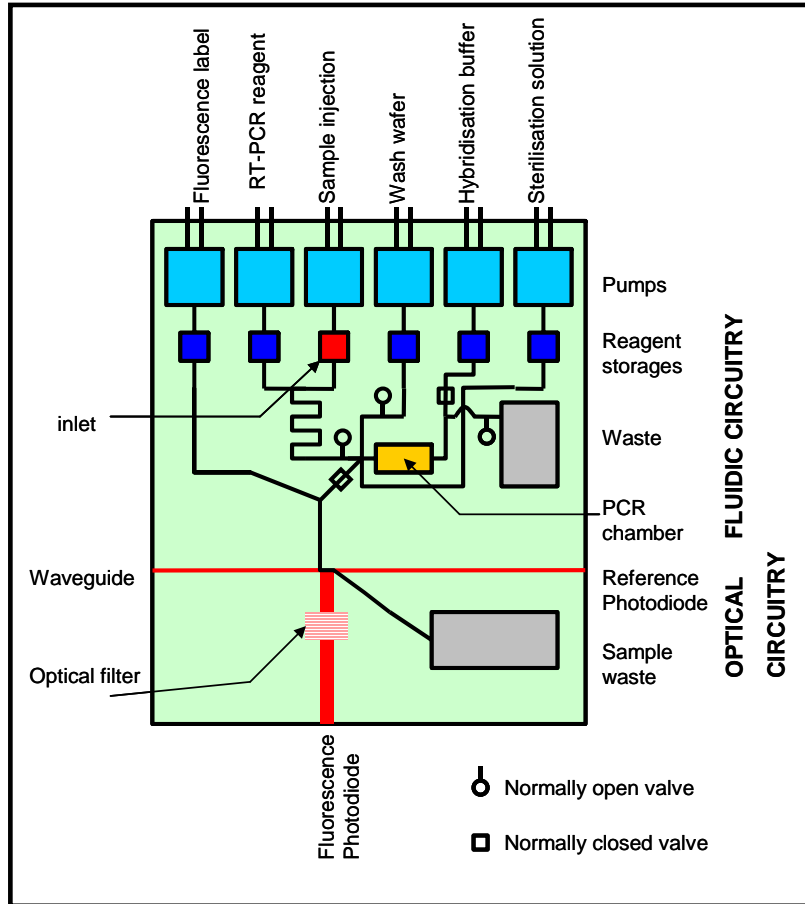

Medical tests



Food diagnostics



OPTOLABCARD – Specific Targeted Research Project

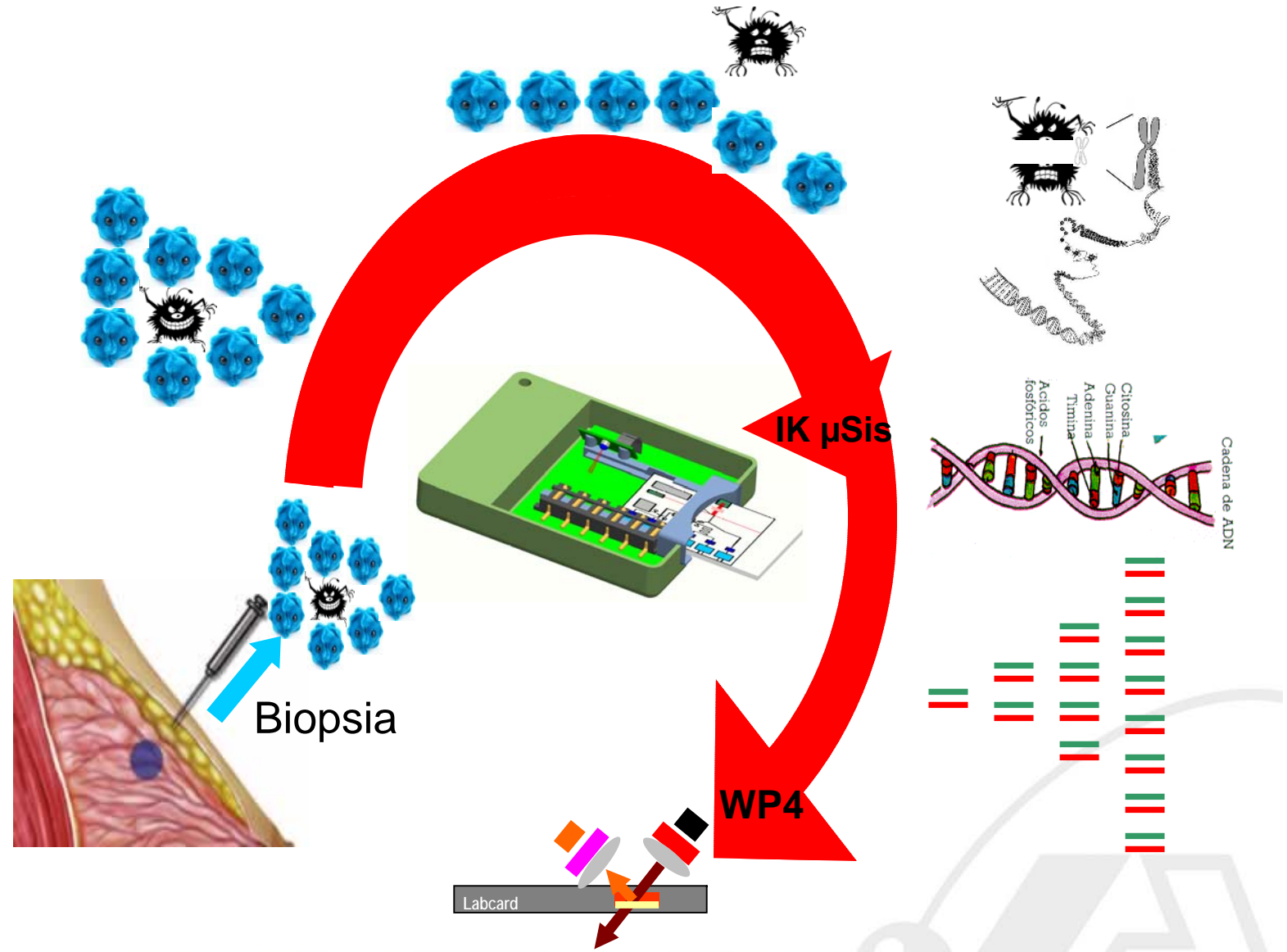



Integrated Project

Project Acronym:
SmartHEALTH

Sistemas de Biodiagnóstico integrados e
inteligentes para el cuidado de la salud

Coordinador:
Calum McNeil
University of Newcastle
United Kingdom

JOINT CALL
Between the IST and the NMP Priorities



Smart HEALTH: Smart sensors solutions for a healthy future (IP EU Project)

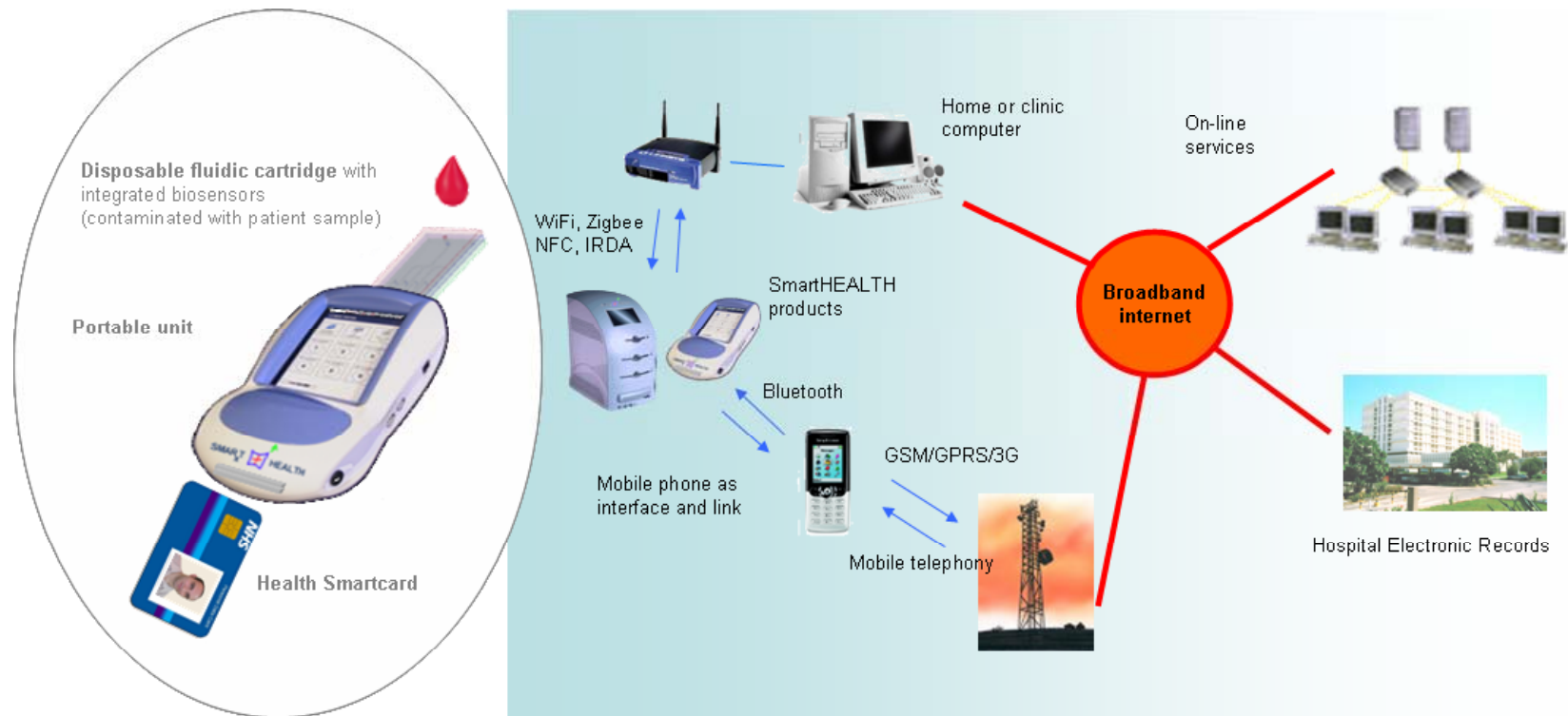

- 7 SCI articles (2004-05)
- 17 conferences in international congress (2004-05)
- Invited oral talk** in 12th Conference on Nanocomposites and Nanoengineering 2005 “Novel 3D Microfluidic Polymeric Technology for Lab-on-a-Chip Applications”.
- Best poster award at Eurosensor XIX (2005)
- Invited oral talk** in 3rd Workshop on Microtechnology for Chemistry and Biology Laboratories, Germany, February 2006
- Participation in: Eurimus TC; NEXUS Medical Devices UC; IBERNAM,...
- Participation in NEXUS network within the “Medical Devices User Club”
- Collaborations with reference centres in Europe: U. Glasgow, MIC, U. Tweente, U. Southampton, IMEC, CNM, UPM, UPC, UB.



Contracted projects

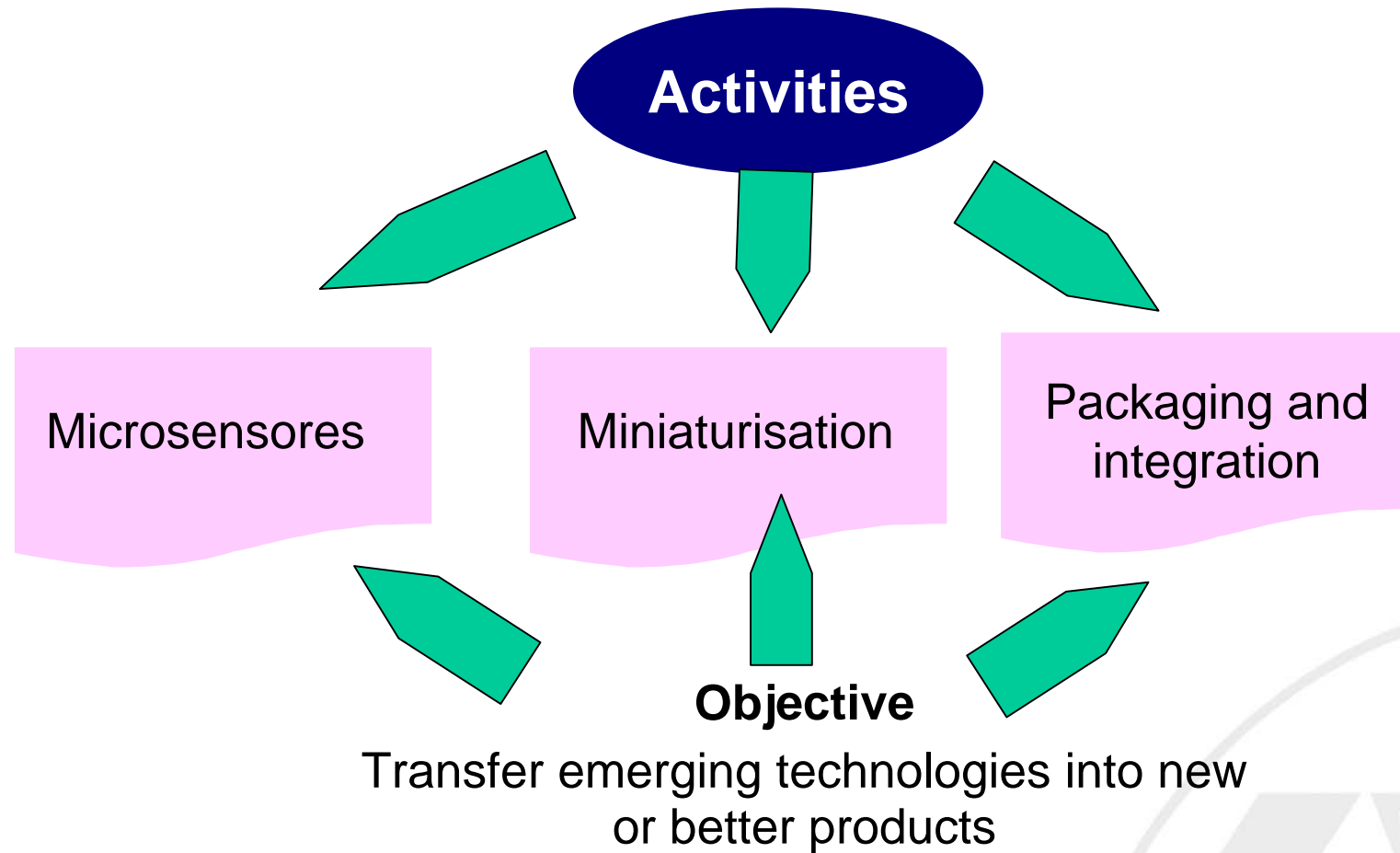

AUTONOMOUS REMOTE SENSING

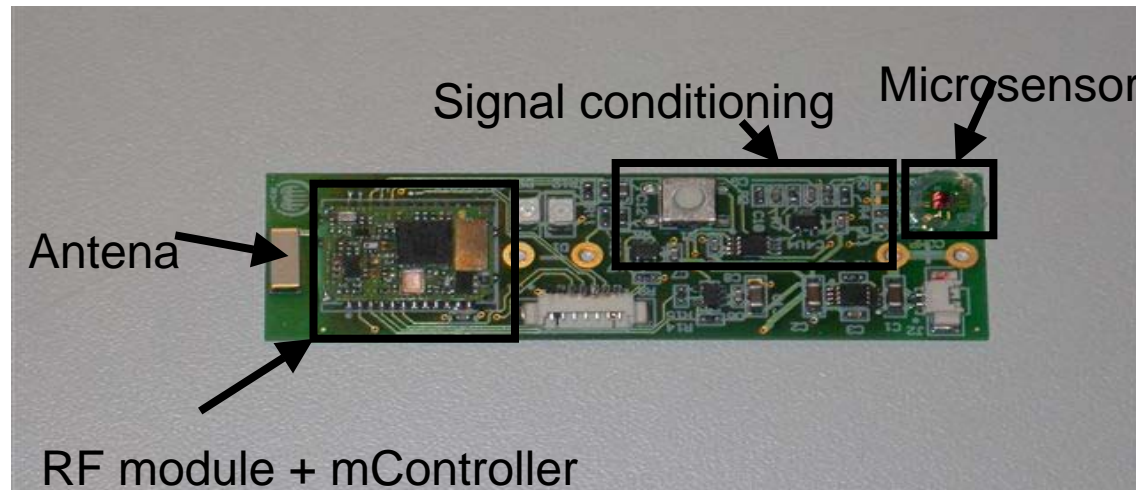

Technology
integration

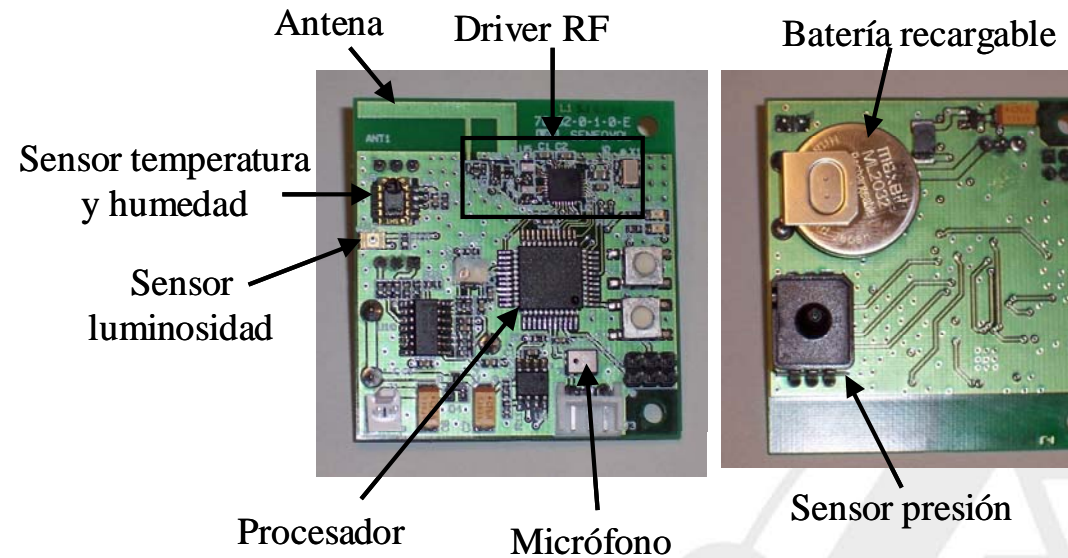

Air flow sensor

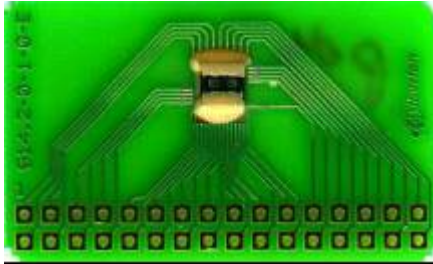

- Flow measured by thermal principle
- Integration with customised pcb and electronics
- Easy interface to an standard gas boiler
- Smart mechanical design to take air sample by venturi effect



Flow microsensor based on differential pressure

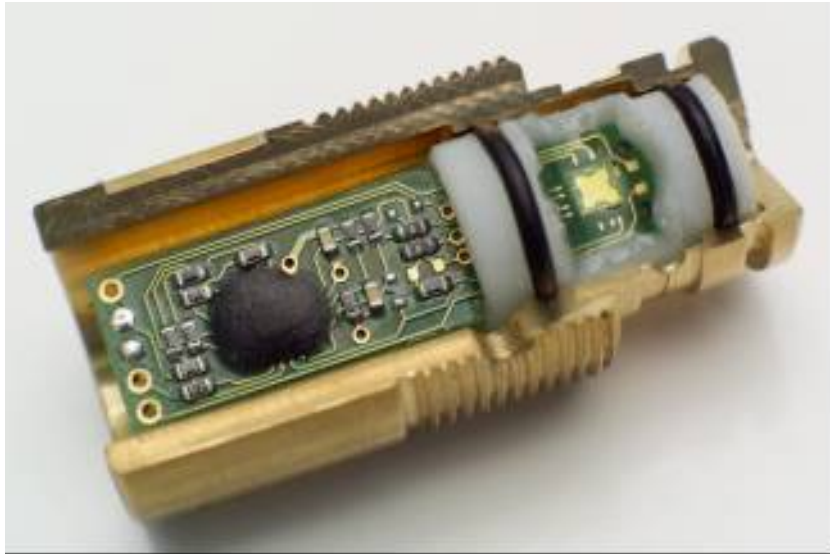
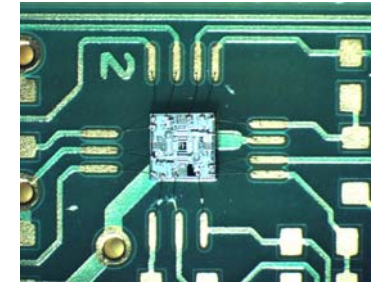
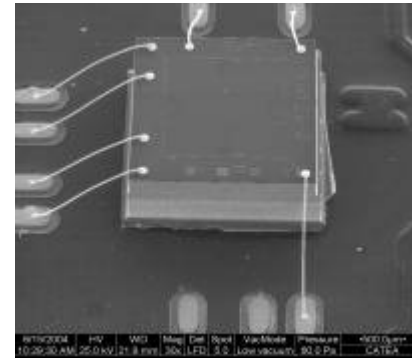

Thermal Conductivity Microsensor

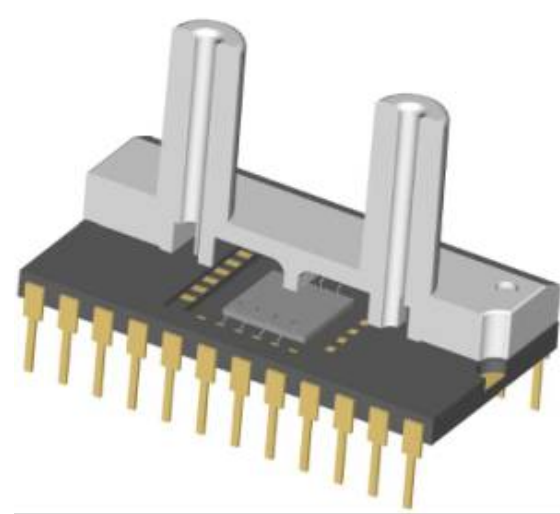

- Applied to measure Methane Number in natural gas
- Method based on the gas Thermal Conductivity measurement and the existing correlative relation between this parameter and the Methane Number of natural gas. The solution consists of two platinum thermoresistances patterned on two microbridges defined on silicon substrate by surface micromachining.

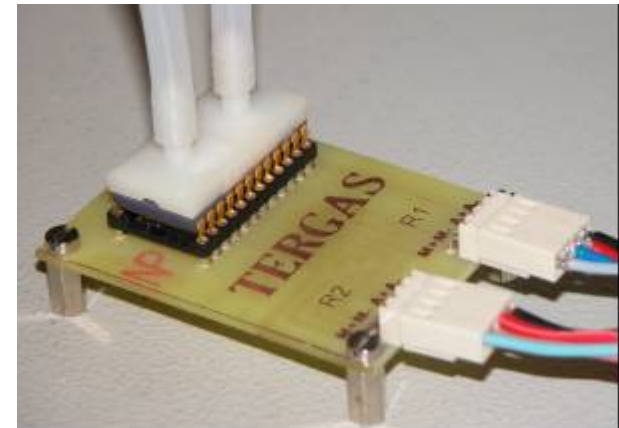

Detection of biological signal

The Life Marker Device should be an instrument capable to identify evidence of extinct life on the exploration of Mars. The approach proposed on this document is based on well known techniques, protein microarrays and measuring fluorescence

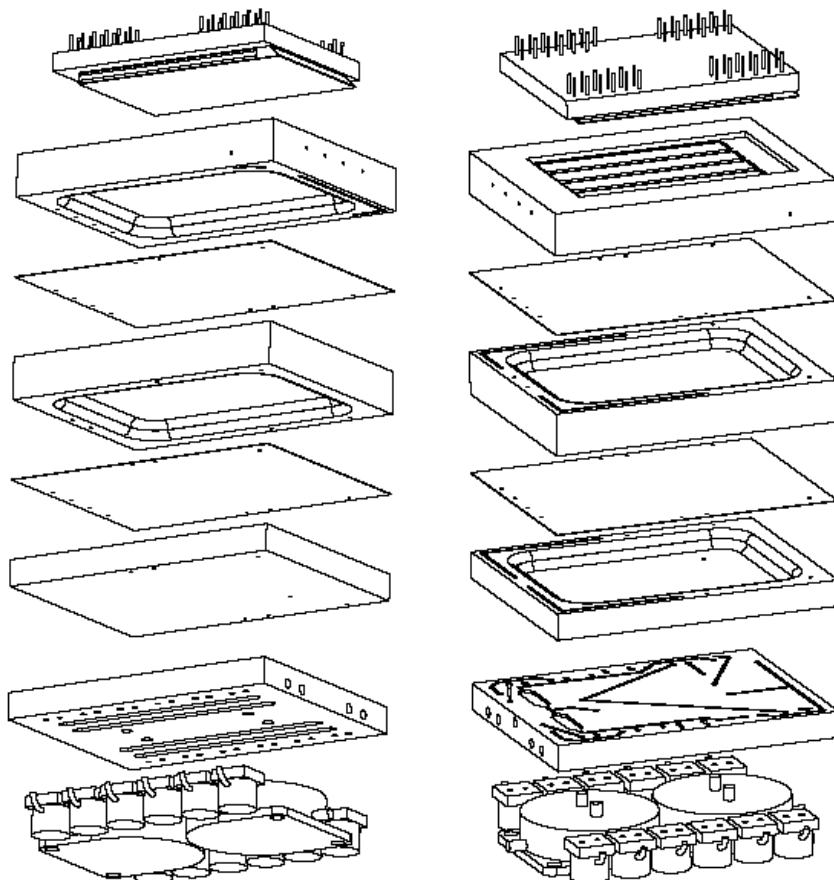

Ags as Tracers

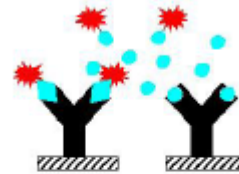

Competitive: Ags in sample compete and displace tracers

Abs as Tracers

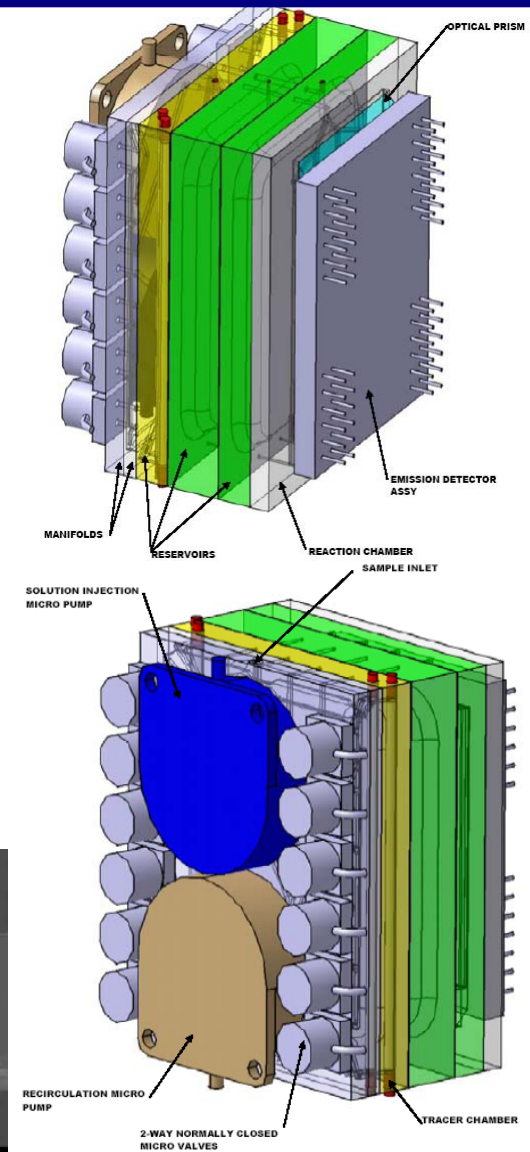
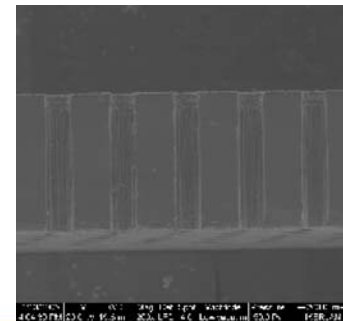
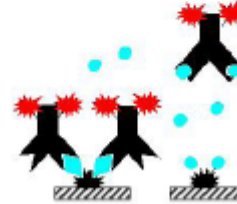

Gas quality sensor

For many gases there is a relation between Wobe index and its dynamic viscosity:

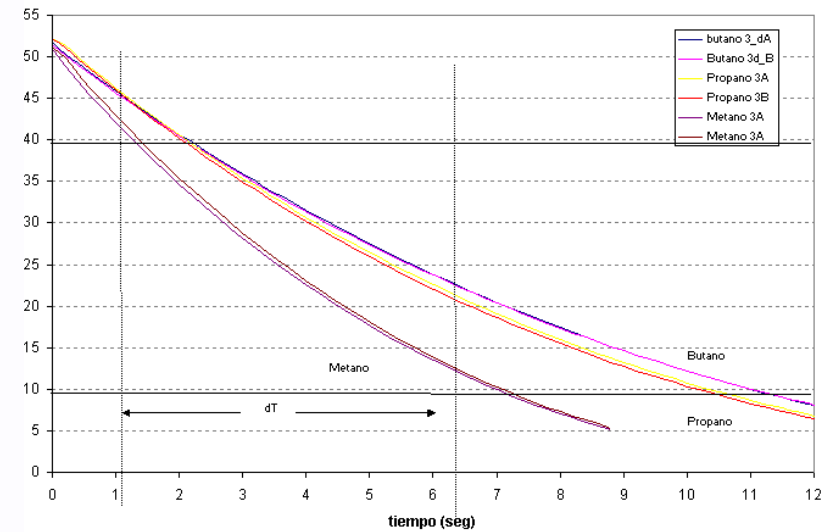
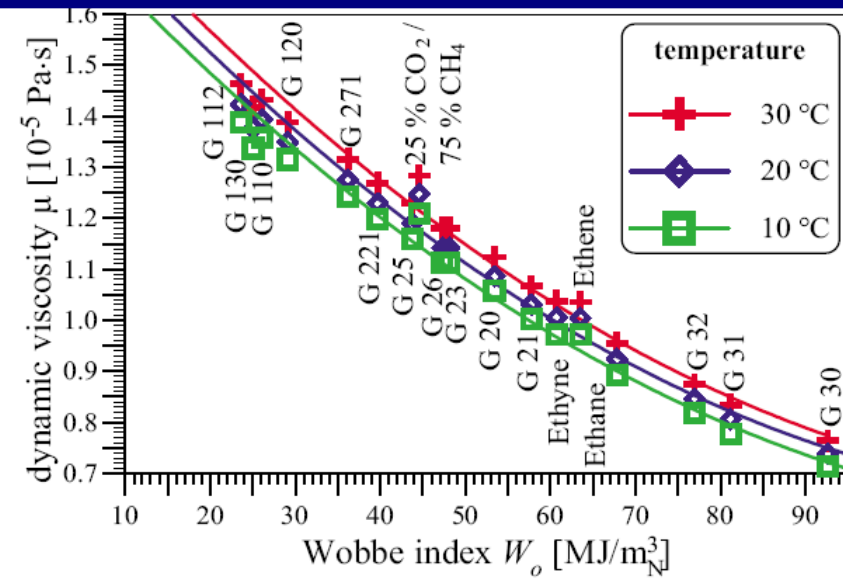
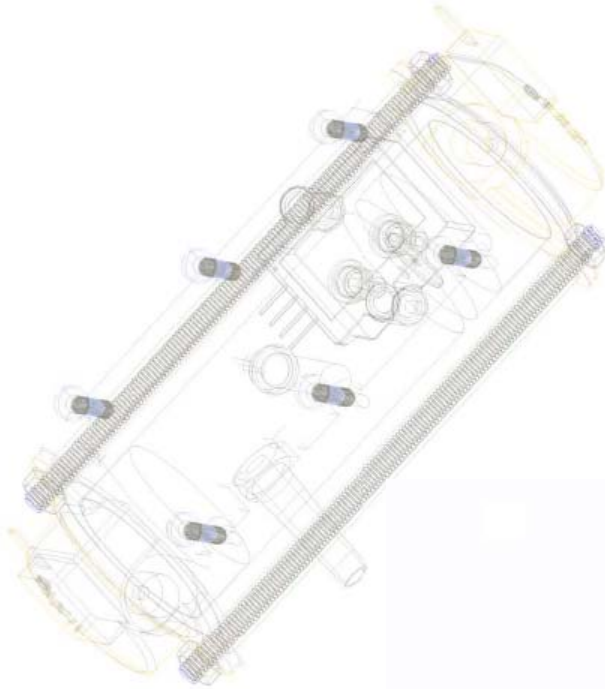

Microsystem for measuring oil degradation in motors and transformers



Sensors



Packaging

SAW device (Surface Acoustic Wave), for viscosity measurement

IDE structure (Inter Digital Electrodes), for impedance measurement

RTD structure (Resistance Thermal Detector), for oil temperature measurement

